

**VIEWTECH**



**VJ-3**

MECHANICAL ARTICULATING  
VIDEO BORESCOPE

---

**USER MANUAL**

# TABLE OF CONTENTS

<b>I</b>	<b>USER NOTICE</b>	<b>1</b>
<b>II</b>	<b>PRODUCT SPECIFICATIONS</b>	<b>4</b>
<b>III</b>	<b>PACKING LIST</b>	<b>6</b>
<b>IV</b>	<b>PRODUCT OVERVIEW</b>	<b>7</b>
<b>V</b>	<b>PART NAMES AND FUNCTIONS</b>	<b>8</b>
<b>VI</b>	<b>PREPARATION</b>	<b>9</b>
6.1	The Case	9
6.2	Power Supply Preparation	10
<b>VII</b>	<b>MENU OPERATION AND FUNCTION</b>	<b>12</b>
7.1	Button Position	12
7.2	Button Function	13
7.3	Overview of Menu Functions	13
7.4	HDMI Output	17
<b>VIII</b>	<b>BASIC OPERATION</b>	<b>18</b>
8.1	Turning On/Off	18
8.2	Inserting the Insertion Tube into the Machinery or Equipment Being Borescoped	19
8.3	Recording Images	19
8.4	Image Playback	21
<b>IX</b>	<b>STORAGE AND MAINTENANCE</b>	<b>22</b>
9.1	Cleaning	22
9.2	Repacking	22
9.3	Storage	22
<b>X</b>	<b>TROUBLESHOOTING</b>	<b>23</b>
10.1	Troubleshooting Guidelines	34
10.2	Repair	23
	<b>PRODUCT WARRANTY</b>	<b>24</b>
	<b>EXTERNAL SPECIFICATION</b>	<b>25</b>

# I USER NOTICE

Please read this user manual carefully before operation.



## WARNING

1. Do not use or store in a place with explosives, a strong magnetic field, or combustible gas.
2. Unauthorized dismantling or modification of this borescope voids the warranty.
3. Make sure the power is turned off before putting the instrument into the carrying case.
4. Never touch the lens/LED module during or immediately after use. Contact may cause burns.
5. If smoke or abnormal noise is detected, stop using and turn off the borescope immediately.
6. Do not look directly at the light from the end of the insertion tube. It is extremely bright and can cause eye damage.
7. If any abnormality is noticed during operation, stop using, and turn off the borescope immediately.

---

---

## ATTENTION

1. **Only use** this borescope within the approved operating temperature range.
2. **DO NOT** over-torque, bend, twist, or fold the insertion tube. Doing so could damage the articulation control wire assemblies and/or electrical wiring.
3. **Only use** the power adapter provided by ViewTech.
4. **DO NOT** yank or attempt to forcefully remove the insertion tube if it becomes stuck inside the equipment being borescoped. When extracting the insertion tube from the inspection area:
  - a. Be sure that the bending section (distal tip of the insertion tube) is straight. Use the joystick to remove any angle before attempting removal.
  - b. If the insertion tube becomes stuck during removal, gently rotate the joystick until it becomes loose again.
5. **After use**, center the joystick in order to straighten the bending section prior to storage. The borescope should always be stored with the bending section straight (do not force the bending section with your fingers – always use the joystick to adjust and straighten the bending angle.)

6. **NOTE** the following regarding the tip of the insertion tube, which is the most delicate part of this video borescope:
  - a. **DO NOT** impact the tip of the insertion tube while inserting or maneuvering inside the equipment being borescoped.
  - b. Manipulate the joystick gently. Rapid movement of the joystick while borescoping may cause abrupt impact with the machinery and result in damage to the camera/LED module.
7. **If** the lens is dirty or greasy, it may be cleaned by wiping with alcohol.
8. **DO NOT** force the joystick! If there is unusual resistance to joystick movement while conducting an inspection, it is because there is physical resistance inside the inspection area. Trying to force the joystick in this situation will result in damage to the articulation control wires, the joystick assembly, or to the equipment being inspected.
9. **DO NOT** impact, press, or scratch the LCD monitor.
10. **DO NOT** cover the unit with a plastic bag or other similar protective covering during use. It may cause the unit to overheat and damage the internal circuitry.
11. **DO NOT** use or store the borescope in a high temperature, high humidity, or high radiation environment.

---

---

## BATTERY AND BATTERY CHARGING

**Follow the instructions below for battery care and proper charging, to prevent leakage, overheating, smoke, explosion, electric shock and burns.**



### DANGER

1. Only use batteries and chargers specially designed for this borescope: 18650B battery with PCB-protection (button top).
2. Be sure the battery is placed into the slot in the correct direction (+ /-).
3. Do not carry or store the battery where it may collide with metal objects.
4. Always keep the batteries away from fire or other sources of intense heat, as it will cause an explosion.
5. Do not attempt to open or modify batteries, as this could lead to an explosion or fire.
6. Do not immerse the battery in liquid of any kind.
7. Do not charge the battery near an open flame, as it could lead to an explosion or fire.
8. Do not drop, puncture, impact, or apply pressure to the battery as it could lead to an explosion or fire.



## WARNING

1. Use only 3.6V lithium batteries, model 18650B with PCB-protection (button top).
2. Submit a repair request immediately in case of battery leakage, discoloration, deformation or abnormal condition.
3. Clean immediately with tap water if your skin or clothing comes into contact with a leaking battery.
4. Keep the battery charger free of any covering during charging.
5. Do not charge the battery in the vicinity of flammable gas or materials.

## ATTENTION

1. Do not use or store the battery or borescope in a high-temperature environment, such as direct sunlight, closed cars or near heating equipment.
2. The battery will heat up during prolonged operation. Do not remove immediately after use, as this could cause burns.
3. Keep battery and borescope out of the reach of children.
4. Do not touch the battery electrodes with wet hands.
5. Fully charge the battery before use and after extended use.
6. Remove the battery from the borescope if the scope will not be used for more than 30 days, otherwise, it may cause a fire damage to the borescope, fire or personal injury.



## REMINDER

1. This is a high-output battery. Please use the battery properly or it may cause damage from leakage or excessive heat. Always check the orientation/polarity and load it into the chamber correctly.
2. Battery performance will decrease as the ambient temperature drops. Performance will be restored once the ambient temperature rises.
3. Recycle the battery in accordance with the local regulations at the end of its useful life.
4. Recommended temperature range for this lithium ion battery is:  
*Discharging (in use):* 0°C to 40°C (32°F to 104°F)  
*Charging:* 0°C to 40°C (32°F to 104°F)  
*Storage:* -10°C to 50°C (14° to 122°F)
5. Using, charging, or storing the battery at a temperature out of the above range will reduce the battery's performance and service life.
6. Be sure to remove the battery from the borescope for long term storage.

# PRODUCT SPECIFICATIONS

Insertion Tube	Outer Diameter
	Length
	Exterior Material
	Chemical Compatibility
	Articulation Range
Optics	Field of View
	Depth of Field
	Illumination Method
	Illumination Output
	Pixels
Base Unit	Display Monitor
	Articulation Control
	Joystick Lock
	Brightness Control
	Function
	Stand-By Time
	Display Resolution
	Internal Storage
	Data I/O Ports
	Battery
	Operating Method
	Dimensions
	Weight
Menu Functions and Options	User Interface
	File Management
	Image Control
	Image Format
	Video Format
	Upgrade
	Angle of Bend
	Language
Operating Limits	Run Time
	Operating Temperature Base Unit
	Operating Temperature Insertion Tube
	Recommended Storage Temperature
	Protection Grade

<b>2.8mm</b>	<b>3.9mm</b>	<b>6.0mm</b>
2.8mm	3.9mm	6.0mm
1.0m, 2.0m	1.5m, 1.5m ST, 3.0m, 3.0m ST	1.5m, 3.0m, 5.0m, 8.0m
Tungsten EasyGlide, crush-resistant		
Water, machine oil, heating oil, diesel, 3.5% saline concentrate		
360° around, 140±10° backward	360° around, 180±10° backward	360° around, 160±10° backward
84° x 84°	90° x 72°: 120°	80° x 60°: 100°
3.0mm - 50.0mm		
4 Super high-intensity white LEDs	6 Super high-intensity white LEDs	
≤ 4,000 Lux	≤ 6,000 Lux	≤ 20,000 Lux
160,000		
3.5" IPS anti-glare LCD		
Thumb-actuated mechanical 360° Omni-directional rocker		
Manual reset/Auto reset		
6-step LED brightness adjustment		
Photo taking, video recording, brightness adjustment		
5 hours		
640 x 480	640 x 480 (Short Tip) 400x400)	640 x 480
16 GB SD Card   10,000 photos, 8 hours video		
SD card, HDMI out, micro-USB		
One 18650 Li-ion battery		
One handed, portable		
13.0" x 12.0" x 4.5"		
2.2 lbs. / 1.0 kg		
Drop down operating menu		
Photo and video recording, playback, thumbnail preview, delete, card formatting		
Image rotation, live freeze, zoom in/out		
JPEG/JPG/PNG (optional date and time stamp)		
AVI (optional date and time stamp)		
Upgrade via SD card		
120 - 180°C		
English (En), Spanish (Es), French (Fr)		
≤ 2.5 Hours	≤ 4 Hours	
14 - 122°F (-10 - 50°C)		
-4 - 140°F (-20 - 60°C)		
14 - 104°F (-10 - 40°C)		
IP67		

### III PACKING LIST

ITEM

1	VJ-3 video borescope
2	18650 Li-ion battery (1 plus spare)
3	18650 Li-ion battery charger
4	Micro USB cable
5	AC power adapter
6	Mini HDMI to HDMI cord
7	16GB SD card + card case
8	SD card reader
9	User manual



## IV PRODUCT OVERVIEW

The VJ-3 mechanical articulating video borescope is a nondestructive visual testing instrument with integrated optics, illumination, image processing, and joystick-actuated steering. It is used for the remote visual inspection of machinery, equipment, and components. The VJ-3 facilitates the visual recording and photo documentation of an inspection of parts and areas of vital equipment that are otherwise inaccessible or that would require great effort and expense to access directly. The VJ-3 consists of two modules integrated into one system: the insertion tube with distally mounted camera/LEDs, and the base unit with control panel, LCD monitor, power source and all necessary circuitry.

The VJ-3 is available from the factory in a variety of configurations suitable for different tasks, with optional insertion tube lengths and diameters, as well as different light wavelengths: white, infrared, or ultraviolet.

The video signal from the VJ-3 can be viewed on the integrated LCD display or on an external television.

---

---

## APPLICATION AND SCOPE

The camera can be used to observe the crack, rust, and foreign substances inside. It is widely used in the production and detection procedures of modern core industries like aviation, automobile, ship, electrical engineering, chemistry, electric power, and so on. The high-brightness LED lighting technology as applied allows the illumination to be more than 10,000 Lux. With the general graphic processor technology, the camera has the best color restoration ability and photo-sensitivity for better color restoration and definition.



**Fig. 4-1** *VJ-3 Articulating Video Borescope*

## V PART NAMES AND FUNCTIONS

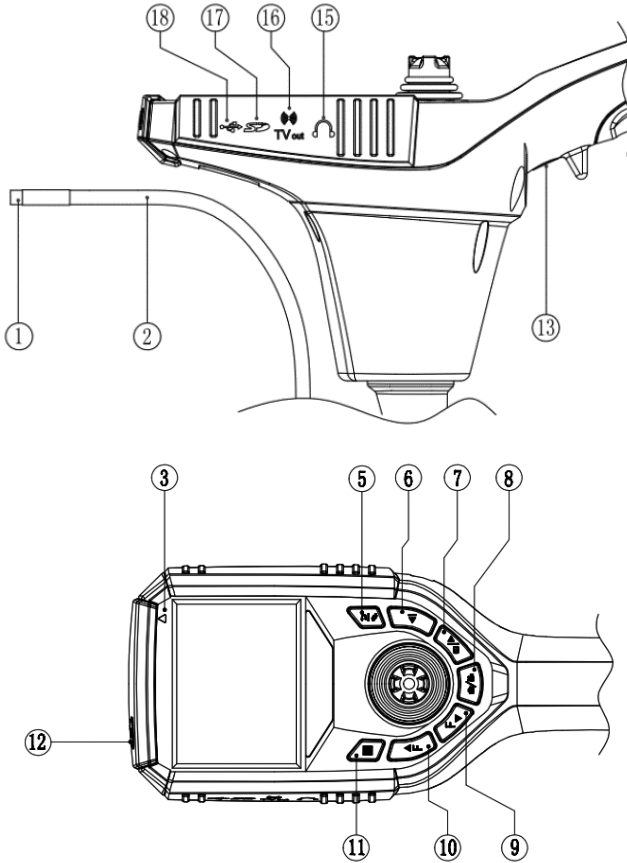

**Fig. 5-1** Part names of the unit

- |   |                                 |
|---|---------------------------------|
| 1. Camera/LED Module                        | 10. Up Key                      |
| 2. Insertion Tube                           | 11. Menu Key                    |
| 3. On-Off/Charging Indicator                | 12. On/Off Button               |
| 5. Return/Photo/Video/Image Playback/Switch | 13. Camera/Video Key            |
| 6. Left Adjustment Key                      | 15. Headset Jack                |
| 7. Right Adjustment /Video Playback Key     | 16. HDMI Video Output Interface |
| 8. Camera/Video Key                         | 17. SD Card Slot                |
| 9. Down Key                                 | 18. Micro USB                   |

## VI PREPARATION

---

### 6.1 THE CASE

#### NOTE

- Before carrying, check the case, handle, and buckles to ensure the case is entirely closed. The case cover may be accidentally opened when lifting if the buckles are not fully closed.
- Always use the provided case to protect the VJ-3 borescope.
- Only remove the instrument from the case when the cover is completely open. This prevents accidents caused by the cover closing unexpectedly.
- Do not operate the borescope from within the case. The case cover may close unexpectedly and pinch the hand.

#### Removing the instrument from the case:

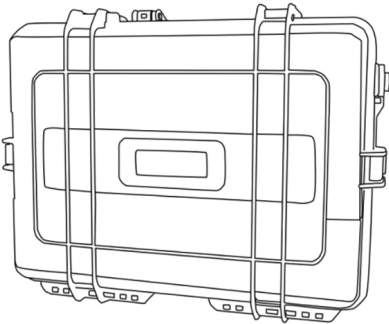
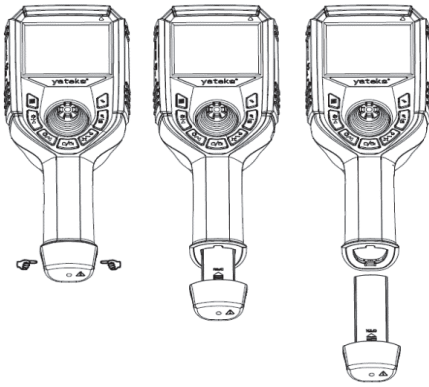

**Fig. 6-1** *The case*

- Place the case horizontally on a flat and stable surface before opening.
- Start by gently removing the insertion tube from the case.
- Once the insertion tube is removed, use your other hand to remove the base unit.

## 6.2 POWER SUPPLY PREPARATION

### REMOVING THE BATTERY



Using your thumb and forefinger, press the two buttons on the sides of the battery chamber at the base of the handle. Pull gently to remove the battery compartment from the handle. (See Fig. 6-2) (as shown in Fig. 6-3).

**Fig. 6-2** Removing the battery compartment

### OPENING THE BATTERY COMPARTMENT

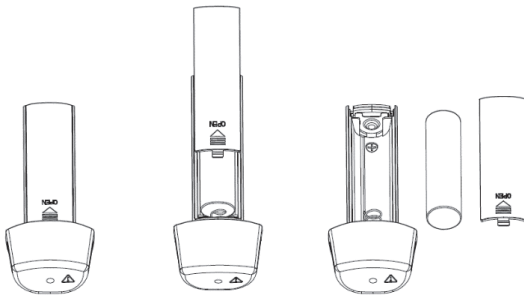

Push the compartment cover down gently with the thumb to open the battery compartment.

**Fig. 6-3** Opening the battery compartment

### LOADING THE BATTERY

Load the 18650B Li-ion battery according to the indications on the positive and negative electrode.

#### ATTENTION

- The battery cannot be placed in reverse polarity.
- Only one 18650B Li-ion battery is required.
- When needed, replace battery with a new 18650B Li-ion battery with PCB-protection circuit.

## BUILT-IN / INTERNAL CHARGING

1. Connect the AC power adapter that is included with your kit to the unit's micro USB battery recharging port.
2. Plug the AC power adapter into a standard wall outlet.
3. The battery is charging when the On/Off Charging Indicator light is red. Charging is finished when this indicator light is green.

### WARNING

- Use only the supplied AC power adapter for recharging the battery—input of 100-240 V (50/60 Hz) AC, output of DC5V 2A, with micro USB interface
- Use of an adapter that does not comply with the above specifications can cause fire, electrical shock, or severe damage to the battery and/or borescope, and will void the warranty.
- The power adapter provided with this product is not waterproof. It may cause electric shock if it comes into contact with water.

## EXTERNAL CHARGING

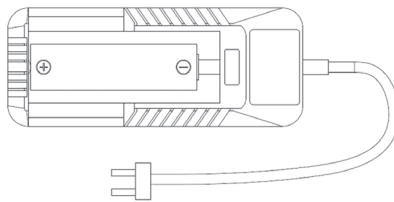

**Fig. 6-4** *External charging*

1. Load the 18650B Li-ion battery into the battery charger with the positive end toward the top of the charger.
2. Plug the charger into a standard wall outlet.
3. The charging is finished when the charger shows 100% or the voltage shows 4.2V.

### NOTE

- Ensure the battery is correctly loaded into the charger.
- The charger has built-in circuitry to prevent over-charging, however the batteries should be removed from the charger and placed back into the carrying case or the borescope after they are fully charged.

# VII MENU OPERATION & FUNCTION

## 7.1 BUTTON POSITION

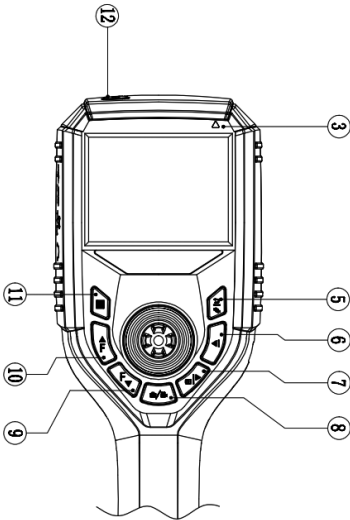

**Fig. 7-1** Button and interface position 1

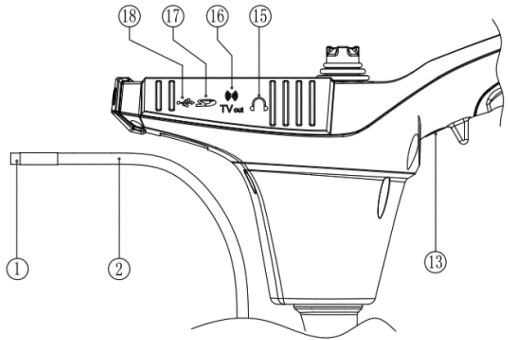









**Fig. 7-2** Button interface, position 2

- |   |                                 |
|---|---------------------------------|
| 1. Camera/LED Module                        | 10. Up Key                      |
| 2. Insertion Tube                           | 11. Menu Key                    |
| 3. On-Off/Charging Indicator                | 12. On/Off Button               |
| 5. Return/Photo/Video/Image Playback/Switch | 13. Camera/Video Key            |
| 6. Left Adjustment Key                      | 15. Headset Jack                |
| 7. Right Adjustment /Video Playback Key     | 16. HDMI Video Output Interface |
| 8. Camera/Video Key                         | 17. SD Card Slot                |
| 9. Down Key                                 | 18. Micro USB                   |

---

---

## 7.2 BUTTON FUNCTION



	The Menu Button is used to display the main menu. When pressed from within the Menu it serves as a selection or confirmation key.
	The Up Key is used to go to a previous page within the menu.
	The Down Key is used to turn to the next page.
	The Camera/Video key is used to take photographs in camera mode, or to start/stop a recording in video mode.
	The Right Adjustment/Video Playback Key is used to adjust the status or function within menus. It is used to play video while in image playback mode.
	The Left Adjustment Key is used to adjust the status or function in the menus.
	The Back/Photo/Video/Image Playback/Switch Key is used to switch between modes. There are four modes; Photo, Video, Image Playback and Video Playback. It is used to execute 'Return' in the menu.
	The ON-OFF key is used for startup and shutdown.

---

---

## 7.3 OVERVIEW OF MENU FUNCTIONS

### 7.3.1 SYSTEM SETTINGS MENU

1. Press the Menu Key  in any mode to enter the main menu, press the Down key  to select system settings (see Fig. 7-3).

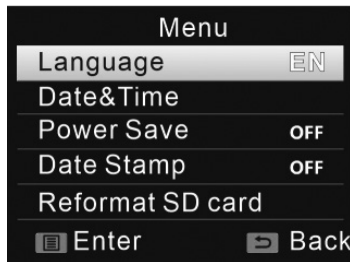





**Fig. 7-3**

2. The system settings menu has seven settings: language, date/time, auto shutdown, date stamp, format, factory setting, and firmware upgrade.

## LANGUAGE SETTINGS

This menu option is used to set the display language on the borescope. You can select from: English (En), Simplified Chinese (Simplified), Traditional Chinese, German (De), Spanish (Es), French (Fr), Russian (RU), Japanese (JP), or Korean (Kr).

## DATE AND TIME SETTING

This menu is used to adjust the time (see Fig. 7-4) and the date. To make changes, press the Back/Camera/Video/Image Playback/Switch key  to switch options, press the Up key  or Down key  to adjust the date. To confirm, press the Menu key . To return to the previous menu press the Back/Photo/Video/Image Playback/Switch key .

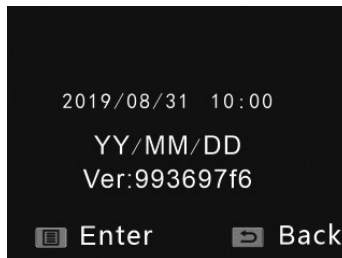

Fig. 7-4

## AUTOMATIC SHUTDOWN

This menu option is used to adjust the automatic shutdown, which is used to conserve battery life if the borescope is not in use for a specified period of time. The options are: 1 min, 3 min, 5 min, or OFF.

## DATE STAMP

This menu option allows you to adjust the date stamp placed on the upper right corner of photos and video. Options available are: OFF, Date, or Date and Time (see Fig. 7-5).

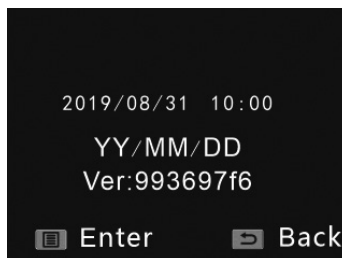

Fig. 7-5



## FORMAT

This Menu option will format the SD card. ALL DATA will be removed from the card and cannot be restored. Select “Yes” on each screen of the Format menu to format the SD card. Do not pull out the SD card during formatting.

## FACTORY RESET

This menu option will restore all system data to the factory setting. After restoring to the factory setting through the option in the menu, select Yes to restore it to the factory setting.

## FIRMWARE UPGRADE

This menu option can be used to update the system software.

### 7.3.2 ON SCREEN LEFT FUNCTION MENU

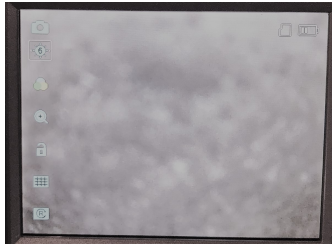

When in Photo or Video mode, press the Up key ▲ or Down key ▼ to access the On Screen Left Function Menu. (Fig. 7-6)



**Fig. 7-6**

This menu contains nine different function settings. The settings are LED brightness, exposure, special effect, zoom-in, freeze, grid, rotation, aspect ratio and white balance.

## LED BRIGHTNESS

This setting adjusts the brightness of the LEDs. Press Up key ▲ or Down key ▼ to access LED Brightness  setting. Adjust the brightness of the LEDs by pressing the Right Adjustment/Video Playback key  or Left Adjustment key .

There are 6 levels for the LED brightness represented by the icons which are:



## SPECIAL EFFECT

This option is used to adjust the color of static images currently displayed and recorded.

**Options are:** Normal or Black and White. The icons displayed for each setting are:



## ZOOM-IN

1. When selected, images can be digitally magnified by 1x (up to 4x) with each press of the Right Adjustment/Video Playback key .
2. To restore the displayed image to it's original size, press the Right Adjustment/Video Playback key repeatedly until the normal zoom is restored.
3. While zooming the screen will display the values of magnification with icons:



## FREEZE

1. When inspecting in real-time, press Freeze to create a still the image on the screen. To defreeze, press the Right Adjustment/Video Playback key to restore the screen to a real-time image display .



### WARNING

- Do not move the insertion tube when the image is frozen as there will be no live display of the movement and damage could occur to the unit.

## GRID

1. An on-screen grid can be displayed. This guide is designed to provide a visual reference for the size of objects on screen.
2. Options: Thick, None, Thin, or Medium represented by the icons which are:



## ROTATION

1. When a real-time image is displayed, it can be flipped or rotated by pressing the Right Adjustment/Video Playback key .
2. There are four options when rotating. Normal, Flipped, Upside Down, and Flipped Upside Down. The icons are:



## 7.4 HDMI OUTPUT

To display the real-time borescope image on an external monitor connect the HDMI cable to the display and the HDMI port on the borescope.

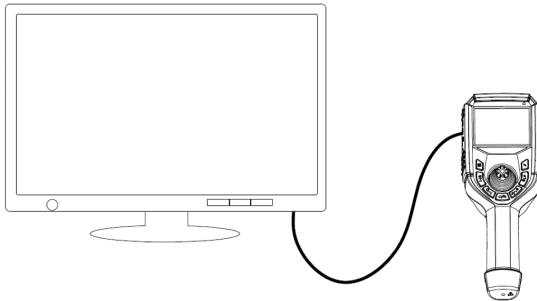

## VIII BASIC OPERATION

### ATTENTION

#### Before turning on the borescope:

- Insert the SD card, otherwise all image capture and video recording functionality will be inoperative.
- Check the lens for any dirt, grime, or debris. Clean as necessary, using the cleaning swabs provided, being careful not to flex the bending section while doing so.



### 8.1 TURNING ON/OFF

Press the On/Off Button  (see Fig. 8-1) near the top corner of the base unit. The borescope will power up and the LCD will display the real-time image captured by the camera/LED module.

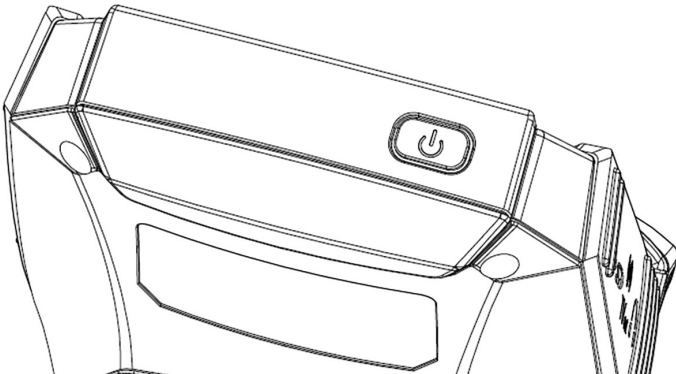

Fig. 8-1 On/Off button

---

---

## 8.2 INSERTING THE INSERTION TUBE INTO THE MACHINERY OR EQUIPMENT BEING BORESCOPED

### Inserting the insertion tube

Make sure the insertion tube and bending section are straight before starting the inspection.

**DO NOT** attempt to articulate the bending section with the joystick while the insertion tube is coiled, as this **can** result in breakage of the articulation control wires.

- After the insertion tube enters the inspection port, adjust the brightness as necessary and use the LCD monitor to see the internal view.
- Manipulate the joystick as needed in order to steer the insertion tube and camera/LED module to the inspection target.



### REMINDER

**STOP IMMEDIATELY** if the joystick control mechanism does not respond to normal inputs or any abnormality occurs during operation. Move the joystick to the center position straightening the distal tip and carefully extract the insertion tube from the inspection area.

### 8.2.1 EXTRACTING THE INSERTION TUBE

1. Move the joystick to the center/neutral position.
2. Withdraw the insertion tube slowly, being careful to hold on to it with one hand so that it does not drop after it exits the inspection access port.



### WARNING

- Do not remove the insertion tube when the bending section is at an angle. Doing so could damage the bending section and/or the equipment being inspected.
- If the insertion tube becomes stuck during the extraction, gently rotate the joystick until it becomes dislodged, and then pull the insertion tube out. Never yank or forcefully remove the insertion tube.

---

---

## 8.3 RECORDING IMAGES

Still images and video can be recorded during live view mode and are stored on the SD card.

### 8.3.1 LOADING THE SD CARD



1. Open the rubber cover on the left side of the base unit.
2. Insert the SD card into the slot with the card's notch pointed toward the top of the base unit, then close the rubber cover.

#### REMINDER

- The SD card is not properly aligned if it does not slide smoothly into the slot. Please check the direction of the card and never use force.
- The file name will automatically be generated when saving images on the SD card.
- For the filename extension, “.JPG” represents the still image file, and “.AVI” represents the video file.
- File numbers are assigned sequentially from 0001 to 9999.

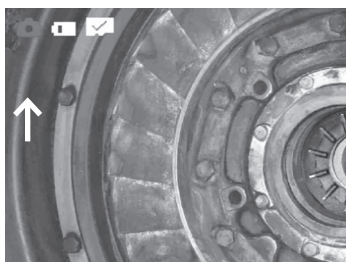
### 8.4.2 TAKING STILL IMAGES





1. When a real time image is displayed press the Back/Photo/Video/Image Playback/Switch key  to switch the mode to camera.
2. Press the Camera/Video trigger button  under the handle grip or in the lower center of the button to record a still image.

**Fig. 8-4** Camera mode indicator

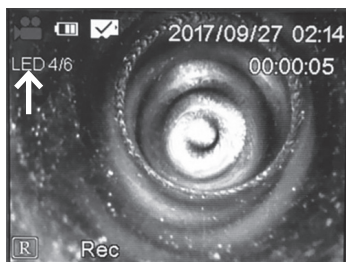
### 8.4.3 RECORDING VIDEO



1. When a real time image is displayed press the Back/Photo/Video/Image Playback/Switch key  to switch the mode to video.
2. Press the Camera/Video trigger button  under the handle grip or in the lower center of the button to record a video. Press it again to stop recording.

**Fig. 8-5** Video mode indicator

---

---





## 8.4 IMAGE PLAYBACK

*See: Full Screen View*



### 8.4.1 MULTI-IMAGE VIEW (THUMBNAILS)

*Not Currently Available on this model*

### 8.4.2 FULL SCREEN VIEW

1. When a real time image is displayed press the Back/Photo/Video/Image Playback/Switch key  twice from camera mode and once from video mode to display an image.
2. Once in the full image view, press the Up key  or Down key  to move to the next image or video.
3. To play a video back, press the Camera/Video key  when viewing the video in Full Screen View.

### 8.4.3 DELETING INDIVIDUAL IMAGES AND VIDEO

1. When reviewing an image in full screen view, navigate to the image or video you want to remove.
2. Press the Menu key  to bring up the prompt “Delete this file?”.
3. Use the Up key  to highlight “Yes” then press the Menu key  again to confirm the deletion.

#### NOTE

- Once you delete that image, another “Delete this file?” prompt will appear on the next image. If you want to keep that image, press the Menu key  when “No” is highlighted and it will remove that prompt.

### 8.4.4 DELETING ALL IMAGES/VIDEOS

*Not available*

#### REMINDER

- Although the option to delete all images/videos is not available, all Images and Videos can be viewed, organized and deleted by removing the SD card from the VJ-3 Borescope and using the supplied SD card reader with your computer.

## 9.1 CLEANING

### CLEANING THE INSERTION TUBE

1. Wipe dirt, grease, grime, and liquids from the insertion tube with a dust-free cloth.
2. Make sure that the insertion tube is completely dry before replacing the borescope back into the case.



### WARNING

Do not store the borescope in a high temperature, high humidity, or corrosive environment.

### CLEANING THE LCD SCREEN

If the LCD screen has fingerprints, grease or stains, wipe the screen with a dust-free cloth.

### CLEANING THE BASE UNIT

Wipe the base unit with a dust-free cloth as needed.

---

---

## 9.2 REPACKING

1. Return the borescope to the case carefully in order to avoid unintentional damage to the insertion tube or camera/LED module.
  2. Be sure that the joystick is in the center/neutral position and that the bending section is straight, prior to inserting the borescope into the case.
  3. When returning the borescope to the case, first place the base unit into the case, then carefully feed the insertion tube into and around the slotted channel in the case that is designed to house the insertion tube.
- 
- 

## 9.3 STORAGE

Store at normal room temperature and humidity.



**X**

# TROUBLESHOOTING

If malfunctions cannot be resolved by following the troubleshooting guidelines below, please contact ViewTech for more detailed troubleshooting instructions or to request a Return Merchandise Authorization (RMA) and repair ticket:

## 10.1 TROUBLESHOOTING GUIDELINES

MALFUNCTION	POSSIBLE CAUSES	PROPOSED MEASURES
Unable to capture images or video	No SD card	Install the SD card correctly
Still showing no SD card after insertion of SD card	SD card is not inserted properly	Re-insert the SD card into the slot
Automatic shutdown	Triggered by too high ambient temperature	Stop using, allow unit to cool down, and then restart
	Triggered by too low battery level	Charge the battery
Unclear image	The camera lens or LCD monitor is dirty	Wipe clean with a dust-free cloth or swabs
Joystick resistance feels high—A lot of pressure is required to move the joystick	The insertion tube is coiled or bent too much	Straighten the insertion tube as much as possible

## 10.2 REPAIR

- Please contact ViewTech before sending your borescope in for repair. A detailed description of the problem and an overview of the operating environment or accident that may have caused the damage will be requested.
- Servicing and repair of this borescope is to be performed only by ViewTech. Do not disassemble or attempt to repair this borescope, as this will immediately void the warranty.

# PRODUCT WARRANTY

The purchased product is covered under the manufacturer product warranty. The warranty becomes effective on the date the purchaser receives the original product. The warranty period is twelve months from the effective date. During the warranty period, the manufacturer will repair, at manufacturer's expense (including shipping expenses), any defective products or components. This warranty covers only those repairs that become necessary due to product defects or defects in manufacturer workmanship. This warranty does not cover damage to the purchased products due to misuse, abuse, or accidents involving the products.

---

---

## INVALIDITY OF PRODUCT WARRANTY

The manufacturer product warranty will be void regardless of the remaining warranty period if the product is opened, customized, or tampered with by an unauthorized technician. If any repair or modification is performed by an unauthorized technician, ViewTech will not be responsible or liable for any damage to persons or property that may result.

---

---



## REPAIR PROCEDURE

To initiate a repair, regardless of whether the repair is under warranty or not, an RMA (Return Merchandise Authorization) number must be obtained. Any item(s) returned without an RMA number cannot be accepted or processed. Please follow the repair procedure as indicated below:

- Call ViewTech at 231-943-1171 to request a Return Merchandise Authorization (RMA) Number.
- Package the unit securely and ship the product to the address that will be provided along with the RMA number.
- Upon completion of the repair, the unit will be returned to the address specified by the customer.

*If the repair falls outside the warranty terms or the warranty period, customer will receive notice of the repair charges prior to repair.*

# CERTIFICATIONS

<p>Low voltage directive and EMC directive</p> 	<p>Conforms to CE</p>
<p>WEEE directive</p> 	<p>Conforms to WEEE</p>
<p>RoHS directive</p> 	<p>Conforms to RoHS</p>

The logo for ViewTech Borescopes features the word "VIEWTECH" in a large, bold, metallic, sans-serif font. The letters have a 3D effect with highlights and shadows. Above the letters, there are several horizontal lines that resemble a borescope tube, ending in a small, stylized arrowhead on the right. Below "VIEWTECH", the word "BORESCOPIES" is written in a smaller, clean, sans-serif font.

**VIEWTECH**  
BORESCOPIES

Traverse City, Michigan, USA

231.943.1171

**[WWW.VIEWTECH.COM](http://WWW.VIEWTECH.COM)**