

VIEWTECH

BORESCOPIES



VJ-4

2.8mm, 3.9mm, 6.0mm & 8.0mm
Dual Camera

MECHANICAL ARTICULATING
VIDEO BORESCOPE

USER MANUAL

TABLE OF CONTENTS

I	USER NOTICE	3
II	PRODUCT SPECIFICATIONS	6
III	PACKING LIST	8
IV	PRODUCT OVERVIEW	9
V	PART NAMES AND FUNCTIONS	10
VI	PREPARATIONS	11
6.1	The Case	11
	Removing The VJ-4 From The Case	11
6.2	Power Supply Preparations	11
	Removing Battery Compartment	11
	Opening/Loading The Battery Compartment	12
	External Charging	13
VII	MENU OPERATIONS & FUNCTIONS	14
7.1	Button Positions	14
7.2	Button Functions	15
7.3	Overview of Menu Functions	16
	Menu & Mode Functions	16
	LED Brightness	18
	Screen Brightness	18
	Display Ratio	19
	Image Rotation & Mirror	19
	Grid Measurement	19
	Image Browsing	20
	Zoom Function	20
	Target Distance	20
	Negative Color	22
	Image Freeze	22
	White Balance	22
7.4	System Settings Menu	23
	Language	24
	Date & Time	24
	Video Format	24
	Image Format	24
	Folders	25
	SD Card Management	27
	Update Software	27
	Hide Icons Delay	27
	Annotation & Review Settings	28
	Auto Shut Down Setting	31
	WiFi Setting	31
	USB Mode Setting	32
	About	32

TABLE OF CONTENTS (CONTINUED)

VIII	BASIC OPERATIONS	33
8.1	Initial Checks	33
8.2	Turning On/Off	33
8.3	Turning White/UV Flashlight On/Off	34
8.4	Inserting The Insertion Tube Into Machinery or Equipment	34
	Extracting The Insertion Tube	35
8.5	Recording Images	35
	Loading The SD Card	35
	Taking Still Images	36
	Recording Video	36
8.6	Image Playback	36
	Multi-Image View	36
	Full Screen View	37
8.7	Deleting Images & Videos	37
	Deleting Individual Images/Videos	37
	Deleting All Images/Videos	38
8.8	System Settings Image Review and Editing	39
	Image Review Icons	39
	Image Editing Icons	40
	Editing Saved Images	41
	Draw Icon	42
	Arrow Icon	42
	Text Icon	42
	Reference Measurement	43
	Settings Icon	47
8.9	Dual Camera Icons	48
	Switching Between Front & Side View Cameras	48
IX	STORAGE AND MAINTENANCE	50
9.1	Cleaning	50
	Cleaning The Insertion Tube	50
	Cleaning the OLED Touch Screen	50
	Cleaning the Base Unit	50
9.2	Repacking	50
9.3	Storage	50
X	TROUBLESHOOTING	51
10.1	Troubleshooting Guidelines	51
10.2	Repair	51
	PRODUCT WARRANTY & REPAIRS	52
	CERTIFICATIONS	53
	NOTES	54

THANK YOU FOR CHOOSING



ViewTech understands how important your video borescope is for business operations.

If technical questions arise, replacement accessories are needed, or inspection requirements change and additional borescopes are required, our video borescope experts are always here to assist!

**PHONE:
1-231-943-1171**

**WEBSITE:
www.ViewTech.com**

**INSTRUCTIONAL
VIDEO LIBRARY**



I USER NOTICE

Please read this user manual carefully before operation.



WARNING

- Do not use or store in a place with explosives, a strong magnetic field or combustible gas.
- Unauthorized dismantling or modification of this borescope voids the warranty.
- Make sure the power is turned off before putting the instrument into the carrying case.
- Never touch the camera / LED module during or immediately after use. Contact may cause burns.
- Do not look directly at the light from the end of the insertion tube. It is extremely bright and can cause eye damage.
- If any abnormality is noticed during operation, stop using and turn off the borescope immediately.

ATTENTION

- **ONLY USE** this borescope within the approved operating temperature range.
- **DO NOT** use sharp objects or strong force when touching or tapping the OLED display. Too much force or using an object besides the provided stylus or fingertip could damage the screen.
- **DO NOT** over-torque, crease, twist or fold the insertion tube. Doing so could damage the articulation control wire assemblies and / or electrical wiring.
- **ONLY USE** the power adapter provided by ViewTech.
- **DO NOT** yank or attempt to forcefully remove the insertion tube if it becomes stuck inside the equipment being borescoped. When extracting the insertion tube from the inspection area, be sure that the bending section (distal tip of the insertion tube) is straight. Use the joystick to remove any angle before attempting removal. If the insertion tube becomes stuck during removal, gently rotate the joystick until it becomes free again.
- **AFTER USE**, center the joystick in order to straighten the bending section prior to storage. The borescope should always be stored with the bending section straight (do not force the bending section with your fingers – always use the joystick to adjust and straighten the bending angle.)

- **NOTE** the following regarding the tip of the insertion tube (bending section and camera module), which is the most delicate part of this video borescope.
- **DO NOT** impact the tip of the insertion tube while inserting or maneuvering inside the equipment being borescoped.
- **ONLY** manipulate the joystick gently. Rapid movement of the joystick while borescoping may cause abrupt impact with the machinery and result in damage to the camera module or articulation.
- **ONLY USE** the recommended alcohol solution when the lens is dirty or greasy and needs to be cleaned.
- **DO NOT** force the joystick! If there is unusual resistance to joystick movement while conducting an inspection, it is because there is physical resistance inside the inspection area. Trying to force the joystick in this situation will result in damage to the articulation control wires, the joystick assembly or to the equipment being inspected.
- **DO NOT** impact, press with excessive force or scratch the OLED display.
- **DO NOT** cover the unit with a plastic bag or other similar protective covering during use. It may cause the unit to overheat and damage the internal circuitry.
- **DO NOT** use or store the borescope in a high temperature, high humidity or high radiation environment.

BATTERIES & BATTERY CHARGING

Follow the instructions below for battery care and proper charging to prevent leakage, overheating, smoke, explosion, electric shock and burns.



DANGER

1. Only use batteries and chargers specially designed for this borescope: 18650B battery with PCB-protection (button top).
2. Be sure the batteries are placed into the chamber in the correct direction (+ /-).
3. Do not carry or store the batteries where they may collide with metal objects.
4. Always keep the batteries away from fire or other sources of intense heat, as it could cause an explosion.
5. Do not attempt to open or modify batteries, as this could lead to an explosion or fire.
6. Do not immerse the batteries in liquid of any kind.
7. Do not charge the batteries near an open flame, as it could lead to an explosion or fire.
8. Do not drop, puncture, impact or apply pressure to the batteries as it could lead to an explosion or fire.



WARNING

1. Use only 3.6V lithium batteries, model 18650B with PCB-protection (button top).
2. Submit a repair request immediately in case of battery leakage, discoloration, deformation or abnormal condition.
3. Clean immediately with tap water if your skin or clothing comes into contact with a leaking battery.
4. Keep the battery charger free of any covering during charging.
5. Do not charge the batteries in the vicinity of flammable gas or materials.



ATTENTION

1. Do not use or store the batteries or borescope in a high-temperature environment, such as direct sunlight, closed cars or near heating equipment.
2. The batteries will heat up during prolonged operation. Do not remove immediately after use, as this could cause burns.
3. Keep batteries and borescope out of the reach of children.
4. Do not touch the battery electrodes with wet hands.
5. Fully charge the batteries before use and after extended use.
6. Remove the batteries from the borescope if the scope will not be used for more than 30 days, otherwise it may cause damage to the borescope, fire or personal injury.



REMINDER

1. These are high-output batteries. Please use the batteries properly or it may cause damage from leakage or excessive heat. Always check the orientation / polarity and load batteries into the chamber correctly.
2. Battery performance will decrease as the ambient temperature drops. Performance will be restored once the ambient temperature rises.
3. Recycle the batteries in accordance with local regulations at the end of their useful life.
4. Recommended temperature range for this lithium ion battery is:
 - *Discharging (in use):* 0°C to 40°C (32°F to 104°F)
 - *Charging:* 0°C to 40°C (32°F to 104°F)
 - *Storage:* -10°C to 40°C (14° to 104°F)
5. Using, charging or storing the batteries at a temperature out of the above range will reduce the battery performance and service life.
6. Be sure to remove the batteries from the borescope for long term storage.

II

PRODUCT SPECIFICATIONS

Insertion Tube	Outer Diameter
	Lengths
	Exterior Material
	Chemical Compatibility
	Articulation Range
Optics	Angle of View
	Depth of Field
	Effective Pixels
	Illumination Method
	Illumination Output
Base Unit	Display Monitor
	Articulation Control
	Brightness Control
	Control Buttons
	Playback
	Audio / Microphone
	Internal storage
	Data I/O ports
	Batteries
	Operating Method
	Dimensions
	Weight
Menu Functions and Options	User Interface
	File Management
	Image Control
	Image Format
	Video Format
	Language
Operating Limits	Run Time
	Operating Temp. Base Unit
	Operating Temp. Insertion Tube
	IP Rating, Insertion Tube

2.8mm	3.9mm	6.0mm	8.0mm
2.8mm	3.9mm	6.0mm	8.0mm
1.0m, 1.5m or 2.0m	1.5m or 3.0m	1.5m or 3.0m	8.0m
Tungsten EasyGlide, crush-resistant			
Water, machine oil, heating oil, diesel, 3.5% saline concentrate			
360° around 130±10° backward (1.0m) 120±10° backward (1.5m) 110±10° backward (2.0m)	360° around 170±10° backward (1.5m) 120±10° backward (3.0m)		360° around 90±10° backward
120° (front) / 120° (side)	110° (front) / 110° (side)	100° (front) / 100° (side)	
Front: 3.0mm - 50.0mm Side: 3.0mm - 50.0mm	Front: 8.0mm - 100.0mm Side: 5.0mm - 50.0mm		Front: 8.0mm - 100.0mm Side: 8.0mm - 50.0mm
160,000 pixels		921,600 pixels	
6 Super high-intensity white LEDs			
Front View ≤ 6,000lux Side View ≤ 6,000lux	Front ≤ 10,000lux Side ≤ 10,000lux	Front ≤ 30,000lux Side ≤ 30,000lux	
5.5" OLED touch screen			
Thumb-actuated, mechanical rocker			
10-step LED brightness adjustment			
Two multi-function mini joysticks and left/right buttons			
Photos, videos (w/wo audio), thumbnail view			
3.5mm port			
32 GB SD Card 10,000 photos, 8 hours video			
SD card, HDMI, USB Type C			
Two 18650B PCB-Protected Li-ion batteries (rechargeable)			
One handed, portable			
13.6" x 6.2" x 7.3"			
2.09 lbs. / .95 kg			
Pop-up menu operation, menu navigation, touchscreen			
Photo and video recording/pause, playback, thumbnail preview, delete			
Image freeze, image flip, zoom in/out			
BMP, PNG or JPG			
AVI or MP4			
English, French, Spanish			
≤ 3 Hours			
-10 – 50°C, -5 – 122°F			
-20 – 60°C, -4 – 140°F			
IP67			

III PACKING LIST

	ITEM
1	VJ-4 video borescope
2	18650B Li-ion batteries (2 plus spares)
3	18650B Li-ion battery charger
4	USB cable
5	Micro USB-C cable
6	HDMI cable
7	AC/DC power adapter
8	32GB SD card + card case
9	User manual
10	Stylus pen
11	Shoulder strap



Fig. 3-1 VJ-4 and Case With All Contents

IV PRODUCT OVERVIEW

The VJ-4 articulating video borescope is a nondestructive visual testing instrument with integrated optics, illumination, image processing and joystick-actuated steering. It is used for the remote visual inspection of machinery, equipment and components. The VJ-4 facilitates the visual recording and photo documentation of an inspection of parts and areas of vital equipment that are otherwise inaccessible or that would require great effort and expense to access directly. The VJ-4 video borescope consists of an insertion tube with distally mounted camera/LEDs and base unit with control panel, OLED display monitor, power source and all necessary circuitry.

The VJ-4 is available in a variety of configurations suitable for different tasks, with insertion tubes of various lengths and diameters, as well as different light wavelengths: white, infrared or ultraviolet.

The video signal from the VJ-4 can be viewed on the integrated OLED touch screen display, on an external hard-wired monitor or via WiFi on a WiFi-enabled device.



Fig. 4-1 VJ-4 Mechanical Articulating Dual Camera Video Borescope

V PART NAMES & FUNCTIONS

5.1 VJ-4 VIDEO BORESCOPE

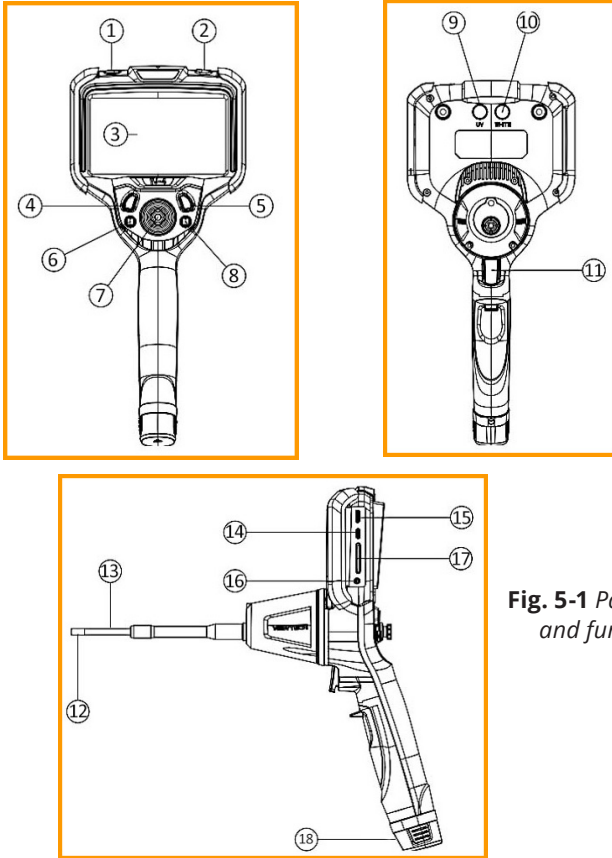

Fig. 5-1 Part names and functions

- | | |
|------------------------------------|----------------------------|
| 1. Flashlight Switch/On/Off Button | 10. White Light Flashlight |
| 2. Power On/Off Button | 11. Photo Capture Trigger |
| 3. OLED Display | 12. Camera/LED Module |
| 4. Left Control Button | 13. Insertion Tube |
| 5. Right Control Button | 14. USB-C Port |
| 6. Left Mini-Joystick | 15. HDMI Video Output Port |
| 7. Articulation Control Joystick | 16. Headset/Mic Jack Port |
| 8. Right Mini-Joystick | 17. SD Card Port |
| 9. UV Light Flashlight | 18. Battery Compartment |

VI PREPARATIONS

6.1 THE CASE:

REMOVING THE VJ-4 FROM THE CASE

- Place the case flat on the floor, table or other stable surface.
- After opening the case, first remove the insertion tube from the case, handling it gently.
- After the insertion tube is removed, use your other hand to grip and remove the base unit.

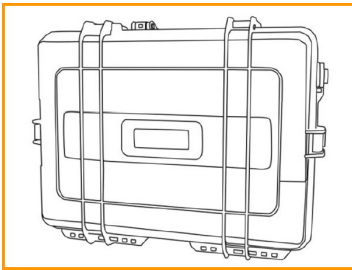

Fig. 6-1 The VJ-4 case

6.2 POWER SUPPLY PREPARATIONS

REMOVING THE BATTERY COMPARTMENT

Using your thumb and forefinger, press the two buttons on the sides of the battery chamber at the base of the handle and gently remove the battery compartment from the handle. (Fig. 6-2).

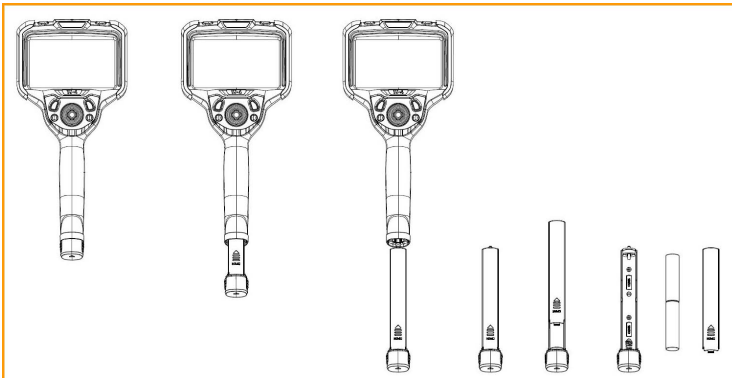

Fig. 6-2 Removing the battery compartment

OPENING/LOADING THE BATTERY COMPARTMENT

Press and hold the battery compartment unlock button according to the arrow instructions and take out the battery compartment (see Figure 6-3). Install the 18650B Li-ion batteries in the compartment, aligned with the positive and negative indicators.

- The batteries cannot be placed in reverse polarity.
- Two 18650B Li-ion batteries are required.
- When batteries no longer hold a charge, replace batteries with new 18650B Li-ion batteries with PCB-protection circuit.

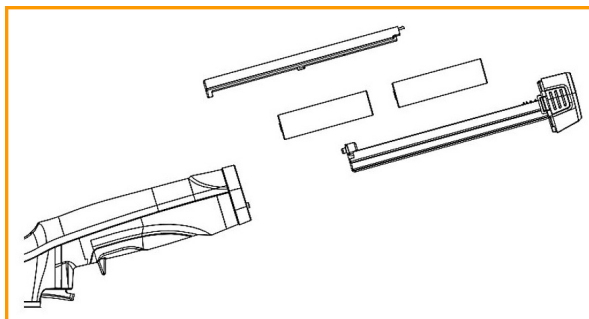

Fig. 6-3 *Opening the battery compartment*



WARNING

- The batteries cannot be charged while still in the borescope.
- Use only the supplied AC power adapter for recharging the battery—input of 100-240 V (50/60 Hz) AC. The adapter output voltage is 12V with an electric current of 3A.
- Use of an adapter that does not comply with the above specifications could cause fire, electrical shock or damage to the batteries and/or borescope and will void the warranty.

EXTERNAL CHARGING

Load the 18650B Li-ion batteries into the battery charger with the positive end toward the top of the charger.

Plug the charger into a standard wall outlet.

The charging is finished when the charger shows 100% for each battery.

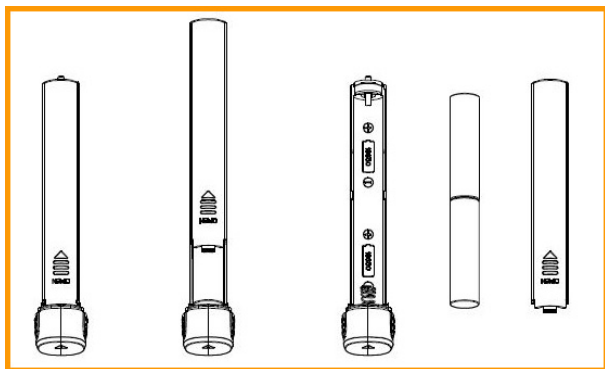

Fig. 6-4 Battery compartment



ATTENTION

- Ensure the batteries are correctly loaded into the charger.
- The charger has built-in circuitry to prevent over-charging, however the batteries should be removed from the charger and placed back into the carrying case or the borescope after they are fully charged.

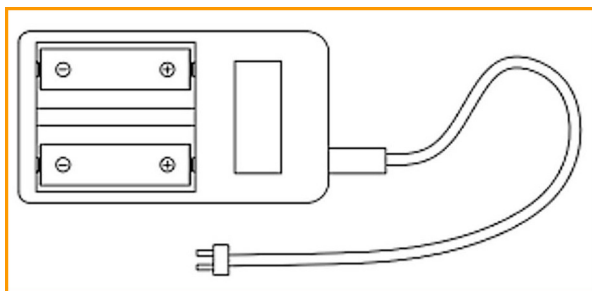

Fig. 6-5 Battery charger

VII MENU OPERATIONS & FUNCTIONS

7.1 BUTTON POSITIONS

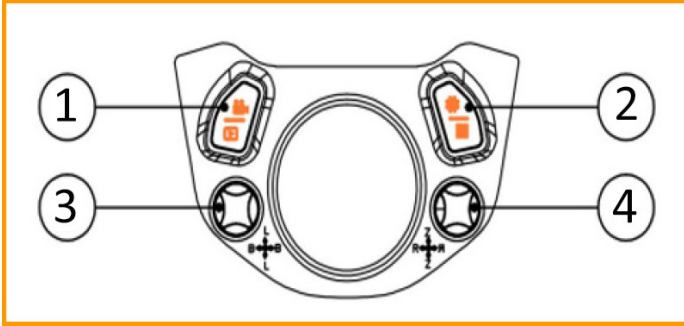

Fig. 7-1 Button Diagram, front view

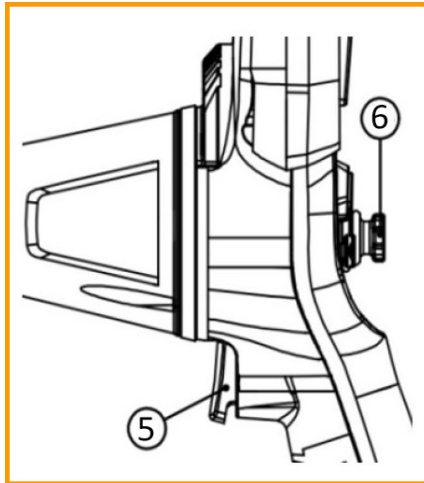







Fig. 7-2 Button Diagram, side view

- | | |
|-------------------------|----------------------------------|
| 1. Left Control Button | 4. Right Mini-Joystick |
| 2. Right Control Button | 5. Photo Capture Trigger |
| 3. Left Mini-Joystick | 6. Articulation Control Joystick |

7.2 BUTTON FUNCTIONS

	<p>Left Control Button</p> <p>Short Press - start/stop video recording</p> <p>Long Press - video/image playback</p> <p>Back Button/Cancel/Exit from system setting mode</p>
	<p>Left Mini-Joystick .</p> <p>Move Up/Down -adjust LED brightness level</p> <p>Move Left/Right -adjust screen brightness</p> <p>Press down on the center to confirm a selection</p> <p>Also used to navigate through menu or system settings mode</p>
	<p>Right Control Button</p> <p>Short Press - switch between live image mode and menu navigation mode</p> <p>Long Press - enter the system settings mode</p> <p>Select/OK in system settings mode</p>
	<p>Right Mini-Joystick</p> <p>Move Up/Down -image zoom in/out</p> <p>Move Left/Right -target distance selection</p> <p>Press down on the center to switch to default setting or confirm a selection</p>
	<p>Photo Capture Trigger</p> <p>Short press - take a photo/capture a photo during video</p> <p>Long Press - switch camera (for dual camera units only)</p>

7.3 OVERVIEW OF MENU & MODE FUNCTIONS

7.3.1 MENU & MODE FUNCTIONS

The VJ-4 user interface (“UI”) is designed to achieve the perfect balance between functionality and simplicity. Every feature and function can be activated, adjusted or controlled with the two mini-joysticks, the two control buttons or the touchscreen. The two mini-joysticks consist of a Left Mini-Joystick (“LMJ”) and a Right Mini-Joystick (“RMJ”). The two control buttons are a Left Control Button (“LCB”) and a Right Control Button (“RCB”).

The overarching framework of this UI consists of three “icon screens” which present three different levels of the user interface:

- **Live Image Mode**
- **Menu Navigation Mode**
- **System Settings Mode**



Fig. 7-3 Live Image Mode

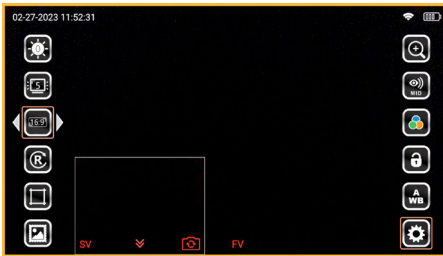

Fig. 7-4 Menu Navigation Mode

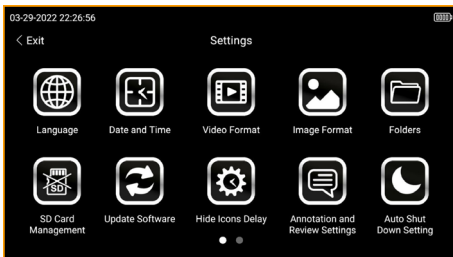

Fig. 7-5 System Settings Mode

7.3.1 MENU & MODE FUNCTIONS CONTINUED

The four icons presented in the Live Image Mode are those used most often during an inspection and are controlled with the LMJ or RMJ. These four icons will appear any time either mini-joystick is moved, and will disappear after 20 seconds of inactivity (see Hide Icons Delay, P. 27).

To adjust:

LED Brightness: Move the LMJ up or down.	Image Zoom: Move the RMJ up or down.
Display Brightness: Move the LMJ left or right.	Target Distance: Move the RMJ left or right.

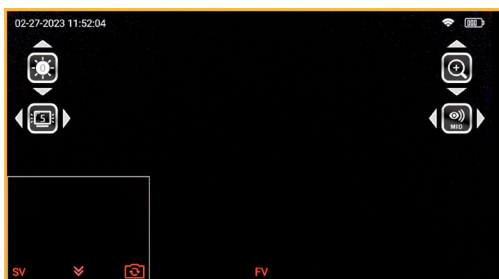

Fig. 7-6 *Live Image Mode*

The Menu Navigation Mode consists of the four icons of the Live Image Mode plus eight additional icons that control :

Display Ratio	Negative Color
Image Rotation & Mirror	Image Freeze
Grid Measurement	White Balance
Image Browsing	System Settings

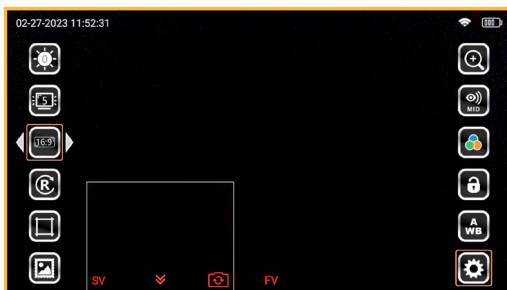













Fig. 7-7 *Menu Navigation Mode*

7.3.1 MENU & MODE FUNCTIONS CONTINUED

To enter the Menu Navigation Mode, press the RCB or tap the screen while in Live Image Mode.

Functions of the 12 icons that make up the Live Image Mode (top 4 icons) and Menu Navigation Mode (all 12 icons):

	LED Brightness		Zoom Function
	Screen Brightness		Target Distance
	Display Ratio		Negative Color
	Image Rotate and Mirror		Image Freeze
	Grid Measurement		White Balance
	Image Browsing		System Settings

LED BRIGHTNESS

The LED brightness level ranges from 1-10.



SCREEN BRIGHTNESS

The screen brightness level ranges from 1-10.







DISPLAY RATIO

There are three options for display ratio: 16:9, 4:3 and 1:1.



IMAGE ROTATION & MIRROR

The live image can be rotated and mirrored with several options available.

	This is the actual image and default setting
	This is 180-degree rotation of the actual image
	This is left and right mirroring of the actual image
	This is up and down mirroring of the actual image

GRID MEASUREMENT

This menu option allows three different size grid sizes to be displayed on the screen to assist with estimating the dimensions of a specific object on the screen.





	No grid selection
	20mm grid
	10mm grid
	5mm grid

IMAGE BROWSING

To view saved images and videos, select the image browsing icon, then touch or toggle to the folder where the images and videos you would like to review are stored. See more details on Folder Management in the System Settings Menu section on page 25.



Fig. 7-8 Folder and Image Management





ZOOM FUNCTION

There are 10 different zoom ratios to choose from: 1.15, 1.30, 1.45, 1.60, 1.75, 1.90, 2.05, 2.20, 2.35 and 2.50.



TARGET DISTANCE

There are four modes available for target distance:

	Middle Range Mode - suitable for most inspections
	Near Range Mode - used for very close distance inspections
	Far Range Mode - used for long distance inspections
	User Defined - users define and set the camera settings

TARGET DISTANCE CONTINUED

When User Defined Distance Mode is selected, the user can manually change color and exposure settings in two tabs. In the Camera Color setting tab the user can adjust Brightness, Contrast, Hue, Saturation, Sharpness, Gamma, Backlight, Noise, Gain and Sensitivity. In the Exposure Control setting tab the user can adjust the Exposure Time.

Color Setting and Exposure Setting

Camera Color Settings Exposure Control

Properties	Max	Min	Set Value
Brightness	64	-64	30
Contrast	95	0	2
Hue	2000	-2000	0
Saturation	100	0	74
Sharpness	64	1	20
Gamma	300	32	109
Backlight	8	0	0
Noise	3	1	1
Gain	0	0	0
Sensitivity	1	0	1

Default Exit OK

Fig. 7-9 User Defined Camera Settings

Color Setting and Exposure Setting

Camera Color Settings Exposure Control

Properties	Max	Min	Set Value
Exposure time	10000	50	166

Default Exit OK

Fig. 7-10 User Defined Exposure Control Settings

NEGATIVE COLOR

This menu option is used to change between color or negative color.



	This is color
	This is negative color

IMAGE FREEZE

This menu option is used to freeze the image currently displayed. Select image freeze again to unfreeze the image. **CAUTION:** Do not move the insertion tube when the image is frozen. You will be unable to visually guide the camera with a frozen image.

	This is live image
	This is image freeze





REMINDER

- The frozen image may be blurry if it was captured while the camera/insertion tube was in motion.

WHITE BALANCE

This menu option allows for automatic white balance or manual white balance. The automatic white balance automatically detects the color temperature of the photographed object and makes color adjustments. To set the manual white balance, at the site of use take a white piece of paper and place it 6-12 inches in front of the camera module, filling the entire screen. This will set the color temperature for the borescope camera.

	This is automatic white balance
	This is manual white balance

7.4 SYSTEM SETTINGS MENU

You can access the third level of the UI, “Systems Settings Mode”, by pressing the System Settings icon in Live Image Mode or by pressing the RCB for 3 seconds.

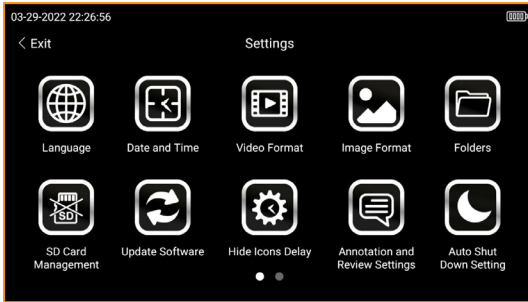

Fig. 7-11 System Settings Mode

The main interface of the System Settings Menu is displayed with two menu screens. To view the second menu screen, swipe the menu to the left or use the mini-joystick to toggle between icons/screens. To enter a setting screen, touch the icon or press down with the mini-joystick to select.

The System Settings Menu controls operational settings for the borescope in the following categories: Language, Date & Time, Video Format, Image Format, Folders, SD Card Management, Update Software, Hide Icons Delay, Annotation & Review Settings and Auto Shut Down Settings on the first screen. The second page of settings includes WiFi Setting, USB Mode Setting and About.

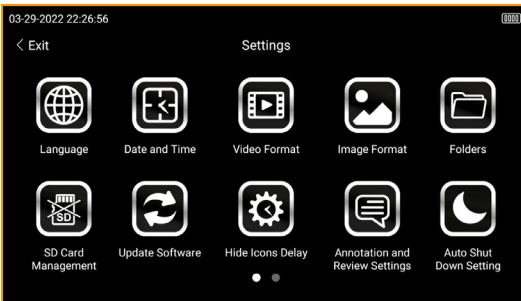

Fig. 7-12 Icons displayed on the 1st System Settings Menu screen

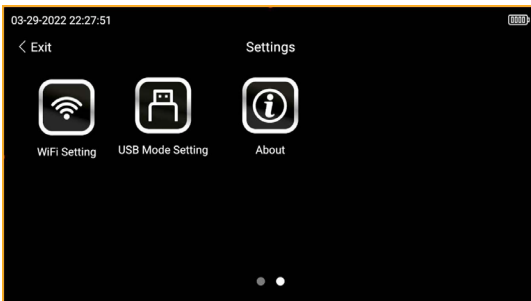

Fig. 7-13 Icons displayed on the 2nd System Settings Menu screen

LANGUAGE

Three different languages are available: English, Spanish and French.

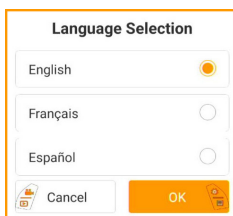

Fig. 7-14 Languages available

DATE & TIME

The date and time can be set in either US or European format.

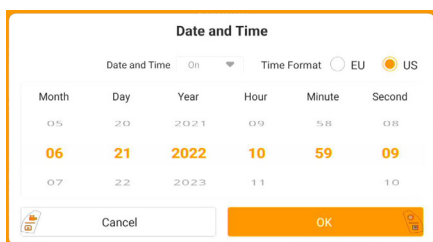

Fig. 7-15 Date and time selection screen

VIDEO FORMAT

Two options for video format are available: AVI or MP4.

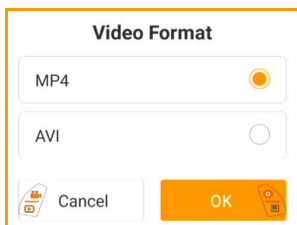

Fig. 7-16 Video file formats available

IMAGE FORMAT

Three options for image format are available: JPG, PNG or BMP.

Note: BMP is the largest size and JPG is the smallest size.

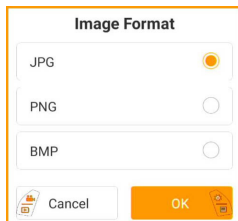

Fig. 7-17 Image file formats available

FOLDERS

This System Settings Menu option facilitates the management of folders to save images and videos, including creating, renaming, deleting or designating a default folder. To add a new folder, first select Create New Folder.

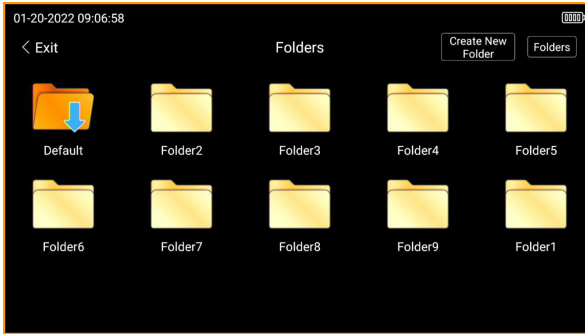

Fig. 7-18 Main folder screen

Next, the new folder will need to be named. After naming the folder, select OK to save.

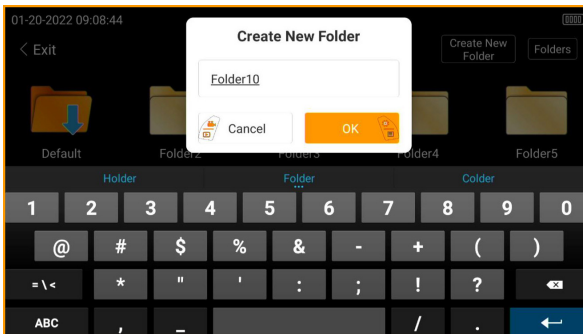

Fig. 7-19 Prompt to add and name a new folder

By selecting Folder, options available include: Rename, Delete or Make Active Folder.

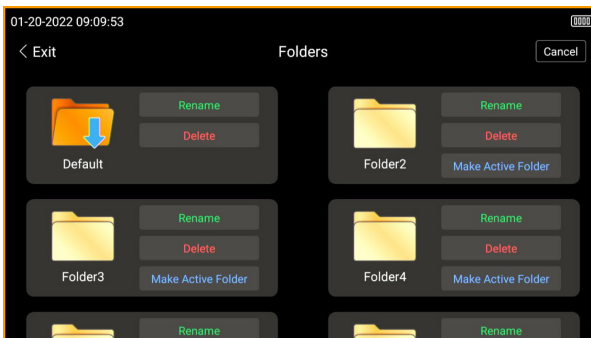

Fig. 7-20 Folder management options

FOLDERS CONTINUED

By selecting Make Active Folder, this folder becomes the destination folder for future images and videos.

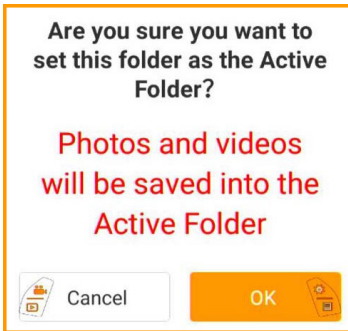

Fig. 7-21 Prompt displayed when selecting a folder as the active folder

By selecting Rename, the name of the folder can be edited or changed.

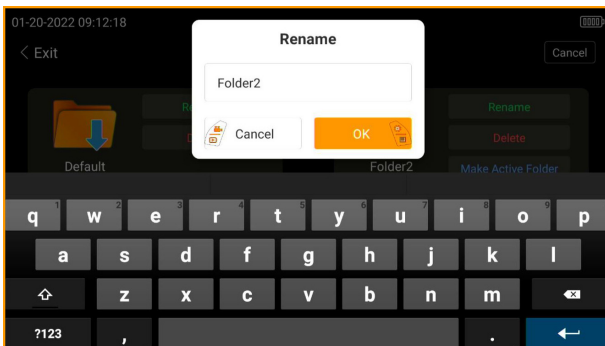

Fig. 7-22 Prompt displayed when renaming a folder

To delete a folder, select delete. **Note:** Folders and images/videos within the folder are not able to be restored after being deleted.

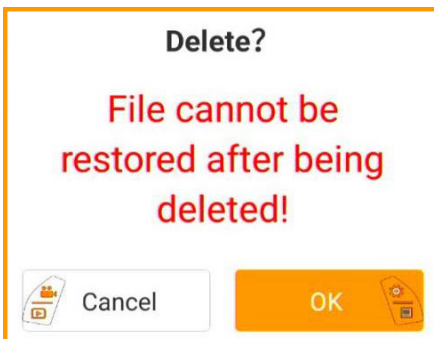

Fig. 7-23 Prompt displayed when deleting a folder

SD CARD MANAGEMENT

When reformatting the SD card, all files and folders are permanently erased.

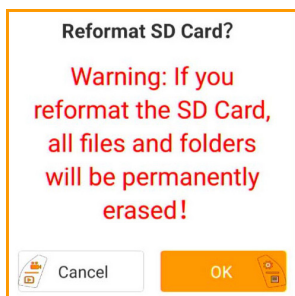

Fig. 7-24 Prompt displayed when selecting to reformat the SD card

UPDATE SOFTWARE

Periodic software updates may become available. This menu option should only be used at the direction of a ViewTech representative.

HIDE ICONS DELAY

In order to preserve as much display area as possible for viewing a live image, the icons in the Menu Navigation mode will automatically turn off after a set period of time of non-use. The hide icons delay will change the time it takes for the screen to switch from Menu Navigation Mode (all icons displayed on the main screen) to Live Image Mode (only four icons displayed on the menu screen).

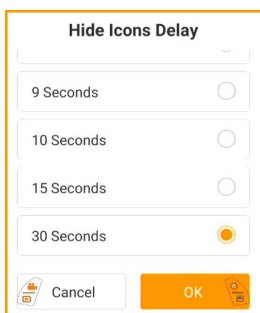

Fig. 7-25 Prompt displayed when changing the time icons are hidden from main screen

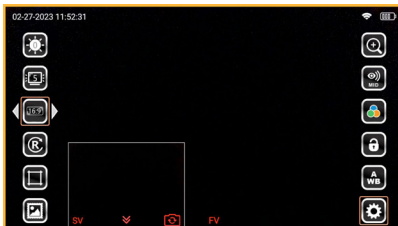

Fig. 7-26 Menu Navigation Mode

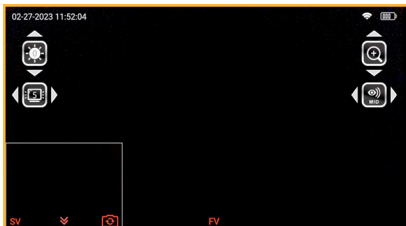

Fig. 7-27 Live Image Mode

ANNOTATION & REVIEW SETTINGS

The VJ-4 video borescope allows custom annotation to be added to images and videos. The Annotation and Review Settings menu allows changes to the settings for photo annotation, video annotation and instant photo review time.

Image Annotation - Selecting yes will cause a dialog box will appear after capturing an image to ask whether or not you would like to add annotation to that image.

Image Review Time - Choose between 2 to 15 seconds for the annotation prompt to be visible. If no selection is made within this time frame, the screen will automatically return to the live image mode.

Video Annotation - Selecting yes will cause a dialog box will appear before a video is recorded asking whether or not annotation should be added to the video. This annotation will appear during the recording and playback.

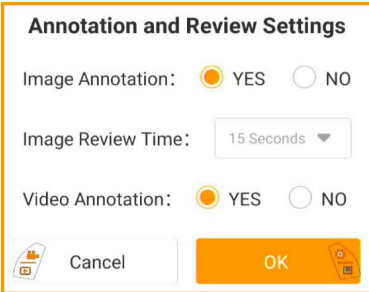

The screenshot shows a dialog box titled "Annotation and Review Settings". It contains three rows of settings:

- Image Annotation: YES (selected) NO
- Image Review Time: 15 Seconds (dropdown menu)
- Video Annotation: YES (selected) NO

At the bottom, there are two buttons: "Cancel" (with a back arrow icon) and "OK" (with a checkmark icon).

Fig. 7-28 Annotation selection settings

NOTE: If video annotation is set to No and image annotation is set to Yes, images captured while recording a video will prompt an annotation dialog box.

Use the touch screen to select No or Yes or press the Right Control Button to add annotation or the Left Control Button to return to the live image screen. When selecting Yes, users are able to save frequently used annotations, add new annotations, delete saved annotations or change the annotation font settings.



Fig. 7-29 Annotation dialog box

ANNOTATION & REVIEW SETTINGS CONTINUED

To create a new annotation, select the plus icon. A keyboard will appear where the text can be added. After typing the annotation desired, touch OK or press the Right Control Button to save. Use the drop down arrow to select a previously saved annotation.

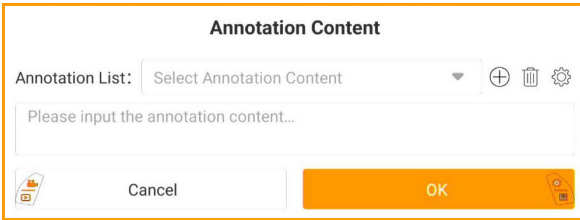

The screenshot shows the "Annotation Content" dialog box. At the top, it is titled "Annotation Content". Below the title, there is a label "Annotation List:" followed by a dropdown menu currently showing "Select Annotation Content". To the right of the dropdown are three icons: a plus sign (+), a trash can, and a gear. Below this is a text input field with the placeholder text "Please input the annotation content...". At the bottom, there are two buttons: "Cancel" on the left and "OK" on the right. The "OK" button is highlighted in orange.

Fig. 7-30 Adding a new annotation

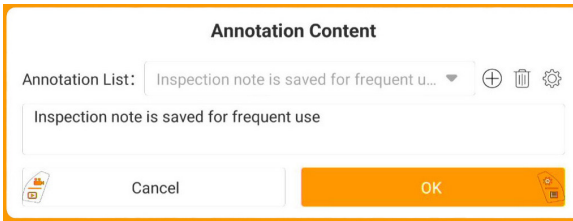

The screenshot shows the "Annotation Content" dialog box. The dropdown menu now shows "Inspection note is saved for frequent u...". The text input field contains the text "Inspection note is saved for frequent use". The "OK" button remains highlighted in orange.

Fig. 7-31 Saving a new annotation

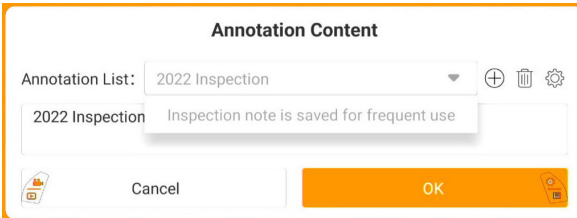

The screenshot shows the "Annotation Content" dialog box. The dropdown menu is open, showing a list of options. The first option, "2022 Inspection", is highlighted. The text input field contains "Inspection note is saved for frequent use". The "OK" button remains highlighted in orange.

Fig. 7-32 Select previously saved annotations

ANNOTATION & REVIEW SETTINGS CONTINUED

If previously save annotations need to be deleted, select the delete icon. The user is able to select one or select all annotations. Once all items that need to be deleted are selected, touch delete or press the Right Control Button to have them removed.

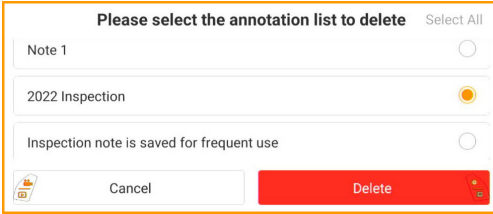

Fig. 7-33 Delete previously saved individual annotations

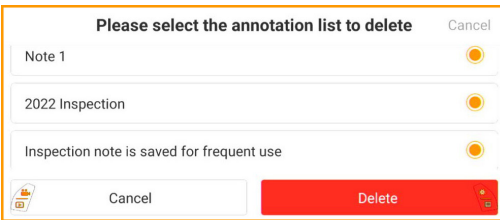

Fig. 7-34 Delete all previously saved annotations with select all

Tapping the settings icon will allow you to change the font size and color that is displayed with any future annotations.

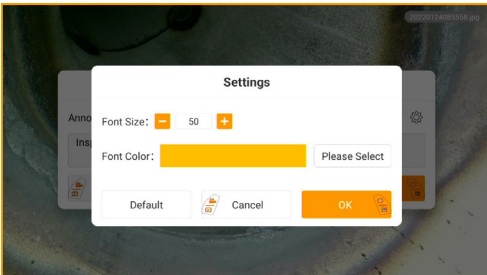

Fig. 7-35 Annotation settings

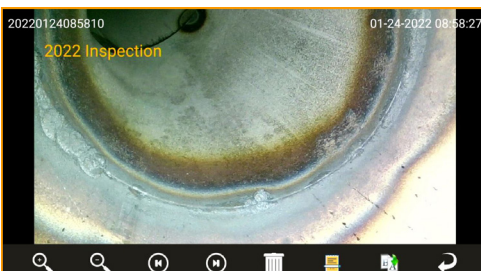

Fig. 7-36 Text annotation is displayed on the image or throughout the video recording

AUTO SHUT DOWN SETTING

The Auto Shut Down Setting allows the borescope to automatically power off when not in use. Select between Always On, 30 minutes, 1 hour, 1.5 hours or 2 hours.

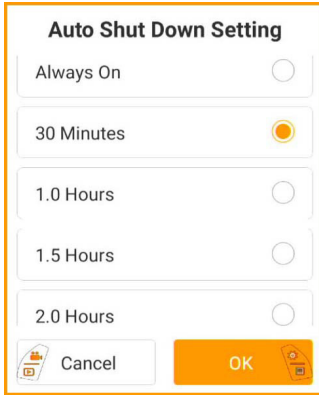

Fig. 7-37 Auto Shut Down selection options

WiFi SETTING

The WiFi setting enables the VJ-4 to be wirelessly connected to a WiFi-enabled device, such as a smartphone, tablet or computer. A WiFi streaming app must be loaded onto the device in order to display the image from the borescope.

Visit www.ViewTech.com/wifi for a list of suggested screensharing smartphone apps, along with FAQs.

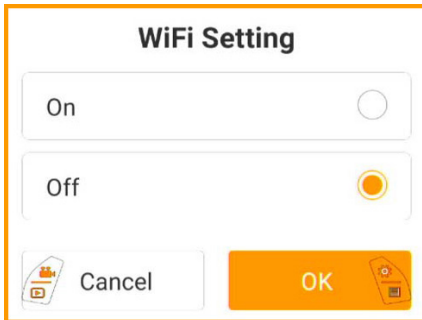

Fig. 7-38 WiFi Setting selection

USB MODE SETTING

When the USB mode setting is set to Read SD Card Files, the image and video files will automatically be displayed when the borescope is connected to a computer. If inactive is selected, image and video files will not be displayed when connected to a computer.

NOTE: powering off the borescope will return USB mode to the default setting of Read SD Card Files.

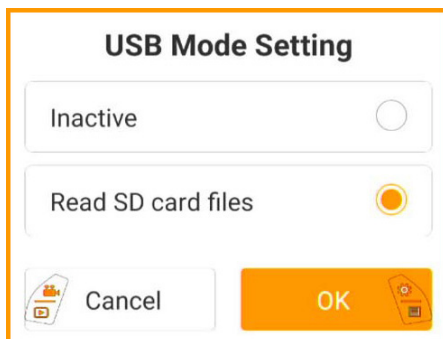

Fig. 7-39 *USB Mode Setting Options*

ABOUT

The About setting will display the current software version.



Fig. 7-40 *About setting display*

VIII BASIC OPERATIONS

8.1 INITIAL CHECKS

ATTENTION

Before turning on the borescope:

- Insert the SD card, otherwise all image capture and video recording functionality will be inoperative.
- Check the lens for any dirt, grime or debris. Clean as necessary, using the cleaning swabs provided, being careful not to flex the bending section while doing so.



Fig. 8-1 *Cleaning the camera at the end of the insertion tube*

8.2 TURNING ON/OFF

Press the on-off button (see Fig. 8-2) near the top corner of the base unit. The borescope will power up and the LCD will display the real-time image captured by the camera / LED module.

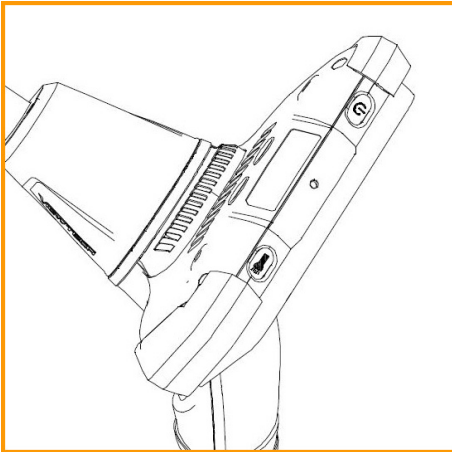

Fig. 8-2 *On/Off button and Flashlight button*

8.3 TURNING WHITE/UV FLASHLIGHT ON/OFF

When pressing the flashlight button adjacent to the power on/off button, the lights on the back of the VJ-4 video borescope switch between a white light flashlight, a UV flashlight and turning off the flashlight. **NOTE:** The UV has a center wavelength of 365nm and luminous power of 50mW.

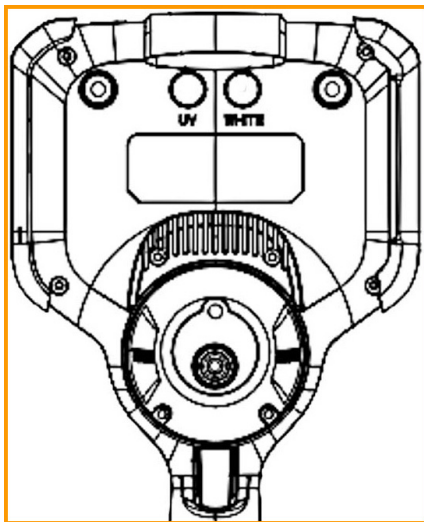

Fig. 8-3 The white and UV flashlight location on the rear of the VJ-4



Fig. 8-4 A white icon is displayed when the white light flashlight is in use

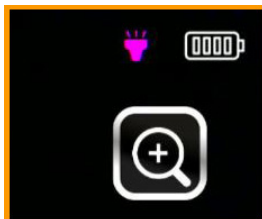

Fig. 8-5 A purple icon is displayed when the UV flashlight is in use

8.4 INSERTING THE INSERTION TUBE INTO MACHINERY OR EQUIPMENT

Inserting the insertion tube:

Make sure the insertion tube and bending section are straight before starting the inspection.

DO NOT attempt to articulate the bending section with the joystick while the insertion tube is coiled, as this will result in breakage of the articulation control wires.

- After the insertion tube enters the inspection port, adjust the brightness as necessary and use the LCD monitor to see the internal view.
- Manipulate the joystick as needed in order to steer the insertion tube and camera/LED module to the inspection target.



REMINDER

STOP IMMEDIATELY if the joystick control mechanism does not respond to normal inputs or any abnormality occurs during operation. Move the joystick to the center position and carefully extract the insertion tube from the inspection area.

8.4.1 EXTRACTING THE INSERTION TUBE

Move the joystick to the center/neutral position.

Withdraw the insertion tube slowly, being careful to hold on to it with one hand so that it does not drop after it exits the inspection access port.



WARNING

- Do not remove the insertion tube when the bending section is at an angle. Doing so could damage the bending section and/or the equipment being inspected.
- If the insertion tube becomes stuck during the extraction, gently rotate the joystick until it becomes dislodged and then pull the insertion tube out. Never yank or forcefully remove the insertion tube.

8.5 RECORDING IMAGES

Still images and video can be captured and recorded during live viewing mode and are stored on the SD card.

8.5.1 LOADING THE SD CARD

Open the rubber cover on the left side of the base unit.

Insert the SD card into the slot with the card's notch pointed toward the top of the base unit, then close the rubber cover.



REMINDER

- The SD card is not properly aligned if it does not slide smoothly into the slot. Please check the direction of the card and never use force.
- The file name will be automatically generated when saving images on the SD card.



Fig. 8-6 SD card insertion

8.5.2 TAKING STILL IMAGES

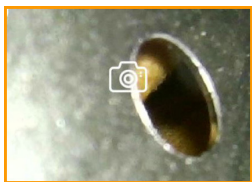

Fig. 8-7 The camera icon displayed when a photo is captured

While a live image is displayed, pull the trigger to capture a still image. A camera icon will appear in the center of the screen when a photo is taken.

While recording a video, pulling the trigger will capture an image without interrupting the video recording.

8.5.3 RECORDING VIDEO

In live image mode, press the Left Control Button to start and stop a video recording. While a video is recording, the recording indicator, video time length and pause recording icon are displayed on the bottom right of the screen. While recording a video, pulling the trigger will capture an image without interrupting the video recording.

When a video is recording, to pause the recording, press the pause recording icon. While the video recording is paused, pressing the record icon to the right of the video time length will resume recording. After video recording has restarted, to end the video recording, press the Left Control Button to stop recording video.



Fig. 8-8 The video recording indicator, pause recording and time length



Fig. 8-9 The resume recording icon will appear after video recording has been paused

8.6 IMAGE PLAYBACK

There are two ways to access and view saved images and videos.

1. Pressing and holding the Left Control Button while in Live Image Mode allows the user to review all images and videos currently saved in the default folder.
2. To view all folders, along with the images and videos saved within the folders, select the Image Browsing icon in the Menu Navigation screen.

8.6.1 MULTI-IMAGE VIEW

By selecting the Image Browsing icon and selecting a folder, all videos and images within that folder will be displayed as thumbnails. Use the Right Mini-Joystick or touchscreen to scroll between photos and images.

8.6.2 FULL SCREEN VIEW

While in multi-image view, select a picture or video to view by pressing the Right Mini-Joystick or by tapping the image or video on the screen with your finger or stylus. To play a video, press the playback button to start viewing the video. NOTE: you can zoom in on a saved image with the pinch-to-zoom on the touch screen.

While in Live Image Mode, pressing and holding the Left Control Button allows for images and videos to be viewed in full screen mode.

8.7 DELETING IMAGES & VIDEOS

8.7.1 DELETING INDIVIDUAL IMAGES/VIDEOS

While in the Folder Management setting, by touching any folder and then selecting the Edit icon at the top right corner, a user is able to multi-select images and videos for deletion. After the selection is complete, touch Delete to remove the selected images and videos. A prompt will be displayed noting “File cannot be restored after being deleted!”. Select Ok to confirm or Cancel to exit.

While in Image Browsing mode, by touching the Delete icon, a user can delete an individual image or video. A prompt will be displayed noting “File cannot be restored after being deleted!”. Select Ok to confirm or Cancel to exit.

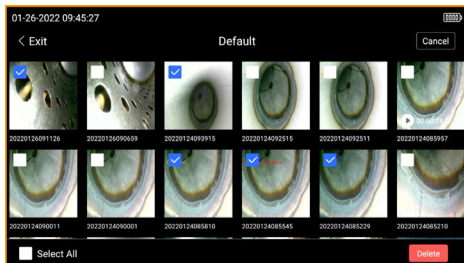

Fig. 8-10 *Selecting and deleting individual images and videos while in the Folder Management setting*

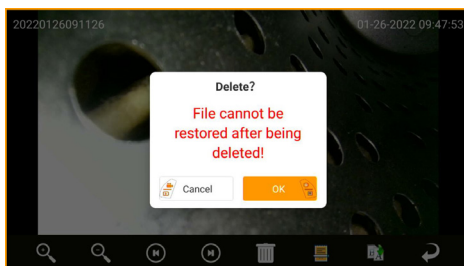

Fig. 8-11 *Selecting and deleting individual images and videos while in the Image Browsing mode with the Delete Icon*

8.7.2 DELETING ALL IMAGES/VIDEOS

While in the Folder Management setting, by touching any folder and then selecting the Edit icon at the top right corner, a user is able to select all images and videos for deletion by touching Select All located at the bottom left corner. After the selection is complete, touch delete to remove all images and videos. A prompt will be displayed noting “File cannot be restored after being deleted!”. Select OK to confirm or Cancel to exit.

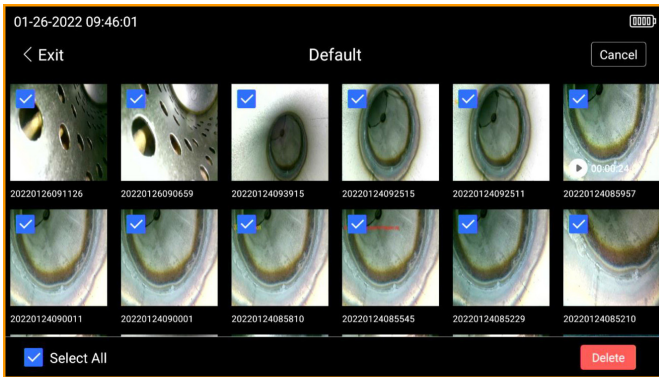

Fig. 8-12 *Selecting and deleting individual images and videos while in the Folder Management setting*

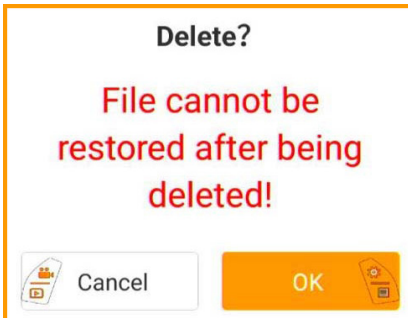









Fig. 8-13 *Prompt displayed to confirm deletion of all images and videos selected*

REMINDER









All Images and Video can be viewed, organized, renamed and deleted by removing the SD card (8.5.1) from the VJ-4 Borescope and using the supplied SD card reader with your computer.

8.8 SYSTEM SETTINGS IMAGE REVIEW & EDITING

8.8.1 IMAGE REVIEW ICONS

	Zoom In	Zoom in on photos
	Zoom Out	Zoom out on photos
	Previous Image	Move to the previous image
	Next Image	Move to the next image
	Delete Image	Delete the current image
	Enter Image Editing Mode	Enter editing mode
	Rename The Current Image	To rename an image or video file name
	Return To Previous Screen	Go back to previous screen

8.8.2 IMAGE EDITING ICONS

	Draw Icon	Select to draw or write free hand on an image
	Arrow Icon	Select to add arrow icons on an image
	Text Icon	Select to type text on an image
	Reference Measurement	Used in reference measurements
	Save Image	Save image with changes that have been made
	Settings Icon	Change the font size, line size, font color, curve color or arrow color
	Undo Changes	Revert to original image prior to any changes being made
	Return To Previous Screen	Go back to previous screen

8.8.3 EDITING SAVED IMAGES



When viewing a saved image, by selecting the Enter Image Editing Mode icon users are able to view all image editing options.

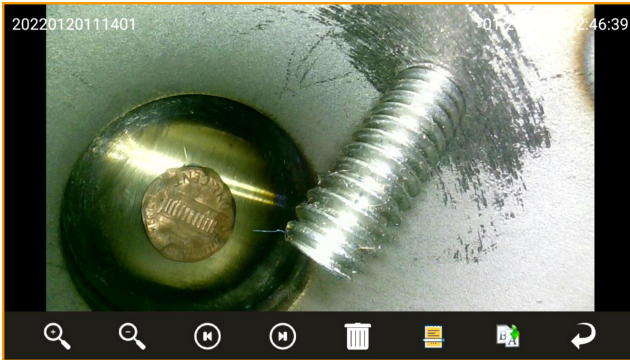

Fig. 8-14 Enter Image Editing Mode



Once in Image Editing Mode, the Draw icon allows users to draw or write free hand on an image with the stylus or finger.



Fig. 8-15 The Draw Icon

8.8.3 EDITING SAVED IMAGES CONTINUED

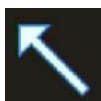

The Arrow icon is used to add arrows to an image.

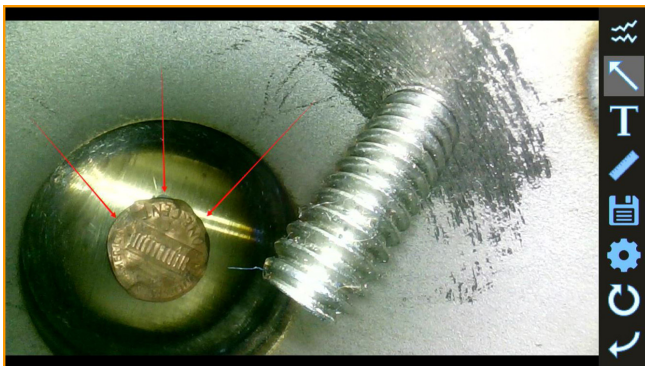

Fig. 8-16 *The Arrow Icon*



When the Text icon is selected, first touch the screen to locate the placement of the annotation. Next, type the text to be displayed and touch OK.

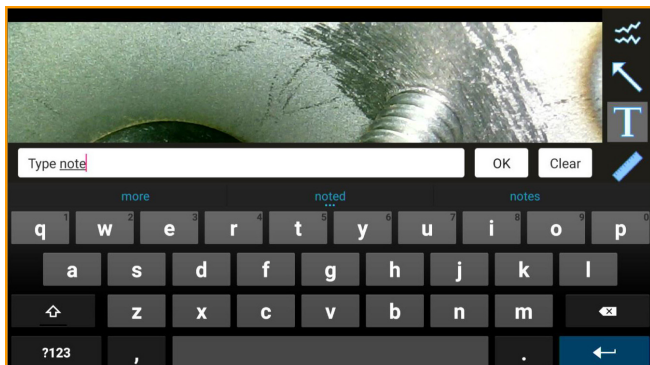

Fig. 8-17 *The Text Icon and Keyboard*

8.8.3 EDITING SAVED IMAGES CONTINUED



Be sure to tap the Save icon in order to save all changes that have been made to the image.

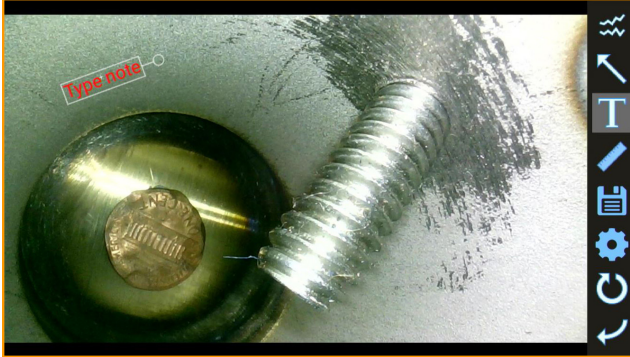

Fig. 8-18 *Text Displayed*



After selecting an image to use in Reference Measurement mode, begin by tapping two points, from left to right, on the screen to indicate your measurement reference.

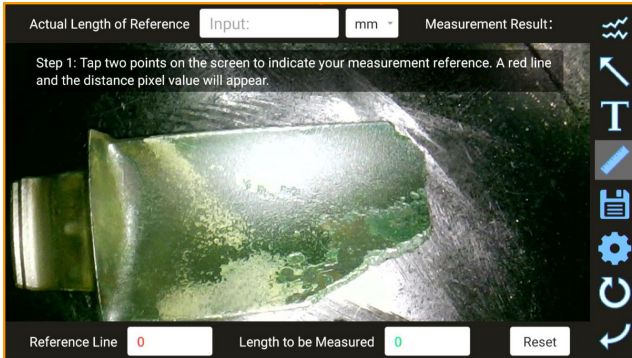

Fig. 8-19 *Select an Image to Calculate Reference Measurement*

8.8.3 EDITING SAVED IMAGES CONTINUED



After completing the reference line, a red line and the distance pixel value will appear.

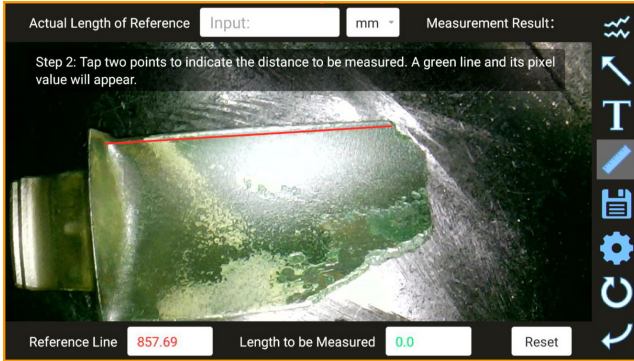

Fig. 8-20 *The Red Line is the Reference Measurement*



Next, tap two points to indicate the distance you would like to be measured. A green line and its pixel value will appear.

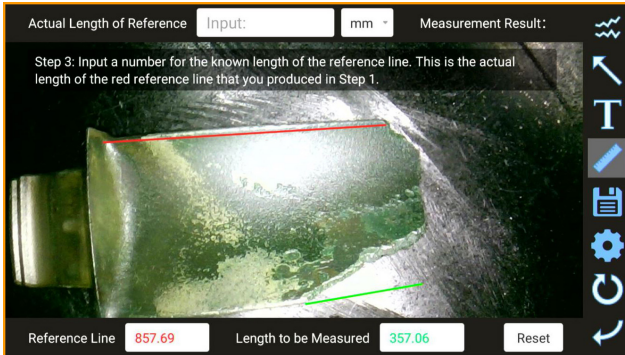

Fig. 8-21 *The Green Line is the Length to be Measured*

8.8.3 EDITING SAVED IMAGES CONTINUED



After both a red reference line and green line to estimate measurement are completed, input a number for the known length of the reference. This is the actual length of the red reference line and can be measured in millimeters, centimeters or meters.

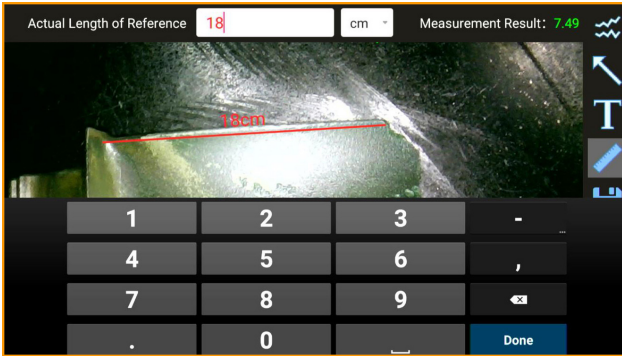

Fig. 8-22 *Input the Known Length of Measurement*



Once the length of the reference line has been input, the measured lengths will be displayed.

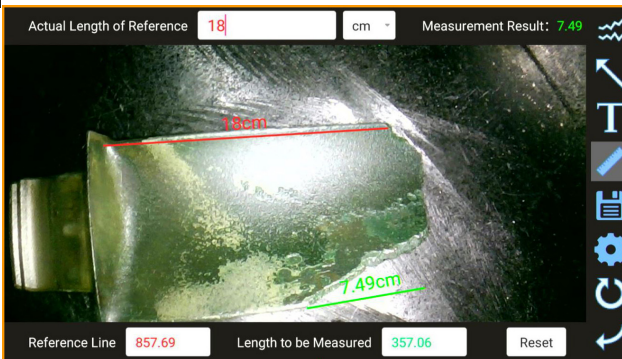

Fig. 8-23 *Length to be Measured is Displayed*

8.8.3 EDITING SAVED IMAGES CONTINUED



Users can then estimate additional lengths to be measured, based on the original length of reference by tapping new areas to be measured. New green lines will appear showing the new measurements.

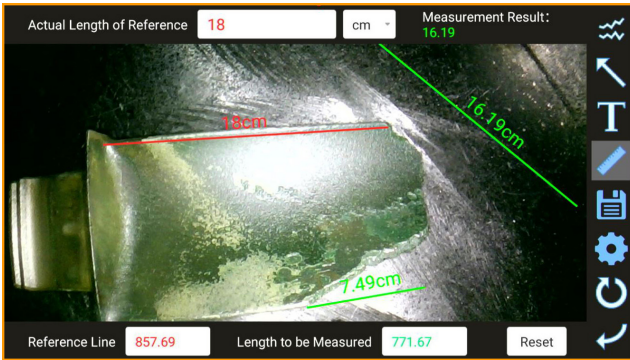

Fig. 8-24 *Multiple Lengths Measured*



Lastly, be sure to save the image for measurement results to be saved. If you were to exit the image without saving, all measurement information will be removed.

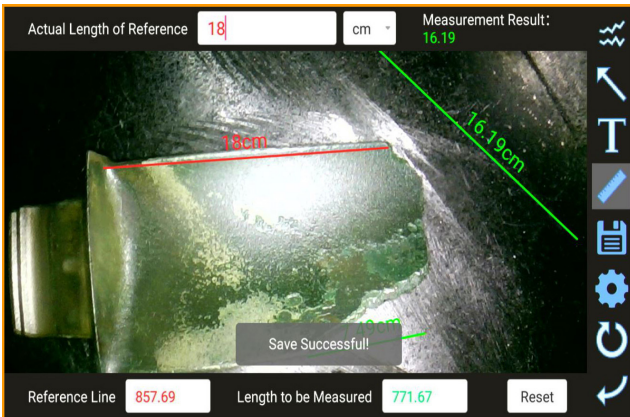

Fig. 8-25 *Save Images Before Exiting*

8.8.3 EDITING SAVED IMAGES CONTINUED



The Settings Icon screen is where font size, line size, font color, line color and arrow color can be adjusted.

A screenshot of a 'Settings' dialog box. It has a title bar 'Settings'. Below it are two rows of controls: 'Font Size: - 53 +' and 'Line Size: - 15 +'. Below these are three color selection rows: 'Font Color:' with a yellow bar and 'Please Select' button; 'Line Color:' with a blue bar and 'Please Select' button; and 'Arrow Color:' with an orange bar and 'Please Select' button. At the bottom are three buttons: 'Default', 'Cancel', and 'OK'.

Fig. 8-26 *The Settings Icon Screen*



After editing saved images, it is generally helpful to rename any image that would need to be referenced later.

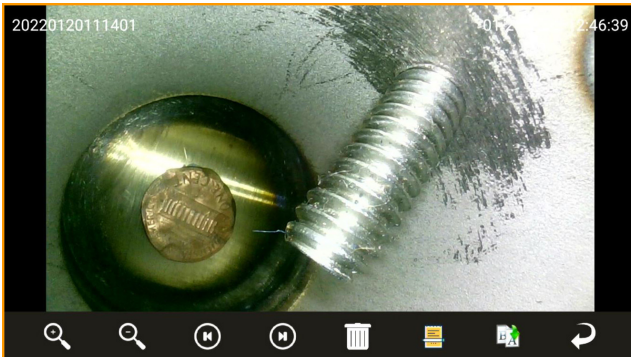







Fig. 8-27 *Rename Current Image Icon*

8.9 DUAL CAMERA OPERATIONS

8.9.1 DUAL CAMERA ICONS

	Camera Switch	Switch between the front view and side view camera as the primary inspection feed
	Front View Camera	Displays with the front view camera
	Side View Camera	Displays with the side view camera
	Hide Camera	Hides the non-primary camera view
	Show Camera	Displays both front and side view inspection feeds

8.9.2 SWITCHING BETWEEN FRONT AND SIDE VIEW CAMERAS

While in Live Image and Menu Navigation Mode, all dual camera operation icons are visible in red at the bottom of the OLED display. When pressing or touching the Camera Switch icon, the primary inspection image and secondary inspection image will switch. Each dual camera perspective is easy to distinguish; the Front View camera angle inspection image is labeled as “FV” and the Side View camera angle inspection image is labeled as “SV”.

If it is preferred to view only the Front View camera or only the Side View camera, begin by pressing or touching the Camera Switch icon so the preferred camera angle is displayed as the primary inspection image. Next, press our touch the Hide Camera icon which then removes the ability to view the secondary inspection image. To return to viewing both Front View and Side View camera angles, press or touch the Show Camera icon.

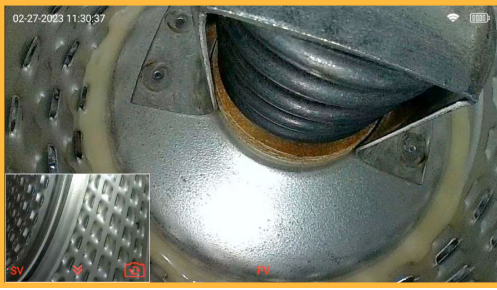

Fig. 8-28 Live Image With the Front View Camera as the Primary Image and the Side View Camera as the Secondary Image

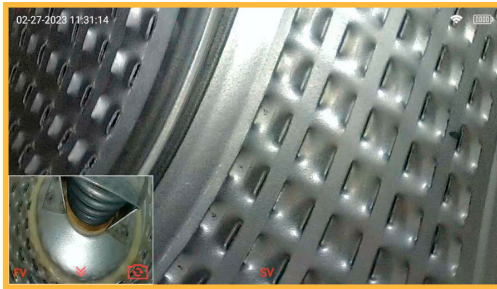

Fig. 8-29 Live Image With the Side View Camera as the Primary Image and the Front View Camera as the Secondary Image

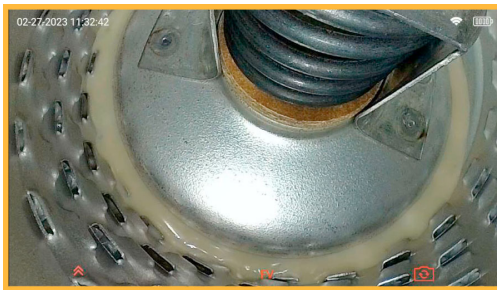

Fig. 8-30 Live Image With the Front View Camera as the Primary Image and the Side View Camera Hidden



Fig. 8-31 Live Image With the Side View Camera as the Primary Image and the Front View Camera Hidden

IX STORAGE & MAINTENANCE

9.1 CLEANING

CLEANING THE INSERTION TUBE

1. Wipe dirt, grease, grime and liquids from the insertion tube with a dust-free cloth.
2. Make sure that the insertion tube is completely dry before replacing the borescope back into the case.



WARNING

Do not store the borescope in a high temperature, high humidity or corrosive environment.

CLEANING THE OLED TOUCH SCREEN

If the OLED touch screen has fingerprints, grease or stains, wipe the screen with a dust-free cloth.

CLEANING THE BASE UNIT

Wipe the base unit with a dust-free cloth as needed.

9.2 REPACKING

1. Return the borescope to the case carefully in order to avoid unintentional damage to the insertion tube or camera/LED module.
 2. Be sure that the joystick is in the center/neutral position and that the bending section is straight prior to inserting the borescope into the case.
 3. When returning the borescope to the case, first carefully feed the insertion tube into the coil-wheel slot, then place the base unit into the case only after the insertion tube is fully inserted.
-
-

9.3 STORAGE

Store at normal room temperature and humidity. Do not store with flammable materials, in direct sunlight or around strong magnetic fields.

X TROUBLESHOOTING

10.1 TROUBLESHOOTING GUIDELINES

If malfunctions cannot be resolved by following the troubleshooting guidelines below, please contact ViewTech for more detailed troubleshooting instructions or to request a Return Merchandise Authorization (RMA) and repair ticket:

MALFUNCTION	POSSIBLE CAUSES	PROPOSED MEASURES
Unable to capture images or video	No SD card	Install the SD card correctly
Still showing no SD card after insertion of SD card	SD card is not inserted properly	Re-insert the SD card into the slot
Automatic shutdown	Triggered by too high ambient temperature	Stop using, allow unit to cool down and then restart
	Triggered by too low battery level	Charge the battery
Unclear image	The camera lens or LCD monitor is dirty	Wipe clean with a dust-free cloth or swabs
Joystick resistance feels high—A lot of pressure is required to move the joystick	The insertion tube is coiled or bent too much	Straighten the insertion tube as much as possible

10.2 REPAIR

- Please contact ViewTech before sending your borescope in for repair. A detailed description of the problem and an overview of the operating environment or accident that may have caused the damage will be requested.
- Repair of this VJ-4 borescope is to be performed only by ViewTech Borescopes. Do not disassemble or attempt to repair the VJ-4 borescope, as this will immediately void the warranty.

PRODUCT WARRANTY

The purchased product is covered under the manufacturer product warranty. The warranty becomes effective on the date the purchaser receives the original product. The warranty period is twelve months from the effective date. During the warranty period, the manufacturer will repair, at manufacturer's expense (including shipping expenses), any defective products or components. This warranty covers only those repairs that become necessary due to product defects or defects in manufacturer workmanship. This warranty does not cover damage to the purchased products due to misuse, abuse or accidents involving the products.

INVALIDITY OF PRODUCT WARRANTY

The manufacturer product warranty will be void regardless of the remaining warranty period if the product is opened, customized or tampered with by an unauthorized technician. If any repair or modification is performed by an unauthorized technician, ViewTech Borescopes will not be responsible or liable for any damage to persons or property that may result.

REPAIR PROCEDURE

To initiate a repair, regardless of whether the repair is under warranty or not, an RMA (Return Merchandise Authorization) number must be obtained. Any item(s) returned without an RMA number cannot be accepted or processed. Please follow the repair procedure as indicated below:

- Call ViewTech at 1-231-943-1171 to request a Return Merchandise Authorization (RMA) Number.
- Package the unit securely and ship the product to the address that will be provided along with the RMA number.
- Upon completion of the repair, the unit will be returned to the address specified by the customer.

If the repair falls outside the warranty terms or the warranty period, customer will receive notice of the repair charges prior to repair.

CERTIFICATION

<p>Low voltage directive and EMC directive</p> <p>CE</p>	<p>Conforms to CE</p>
<p>WEEE directive</p> 	<p>Conforms to WEEE</p>
<p>RoHS directive</p> <p>RoHS</p>	<p>Conforms to RoHS</p>

NOTES



Traverse City, Michigan, USA
1.231.943.1171

WWW.VIEWTECH.COM

**SCAN THE QR CODE BELOW TO VIEW THE
MOST RECENT VERSION OF THE VJ-4 USER MANUAL
IN A DIGITAL FORMAT.**

