

VIEWTECH



VJ-3 Dual Camera

MECHANICAL ARTICULATING
VIDEO BORESCOPE

USER MANUAL

TABLE OF CONTENTS

I	USER NOTICE	1
II	PRODUCT SPECIFICATIONS	4
III	PACKING LIST	6
IV	PRODUCT OVERVIEW	7
V	PART NAMES AND FUNCTIONS	8
VI	PREPARATION	9
6.1	The Case	9
6.2	Power Supply Preparation	9
VII	MENU OPERATION & FUNCTION	12
7.1	Button Position	12
7.2	Button Function	13
7.3	Overview of Menu Functions	13
VIII	BASIC OPERATION	17
8.1	Turning On/Off	17
8.2	Inserting the Insertion Tube into the Machinery or Equipment Being Borescoped	18
8.3	Image Display Adjustment	19
8.4	Recording Images	20
8.5	Image Playback	22
8.6	Deleting Images and Video	23
8.7	Menu Operation	24
IX	STORAGE AND MAINTENANCE	25
9.1	Cleaning	25
9.2	Repacking	25
9.3	Storage	25
X	TROUBLESHOOTING	26
10.1	Troubleshooting Guidelines	26
10.2	Repair	26
	PRODUCT WARRANTY	27
	EXTERNAL SPECIFICATION	28
	NOTES	29

I USER NOTICE

Please read this user manual carefully before operation.



WARNING

1. Do not use or store in a place with explosives, a strong magnetic field or combustible gas.
2. Unauthorized dismantling or modification of this borescope voids the warranty.
3. Make sure the power is turned off before putting the instrument into the carrying case.
4. Never touch the lens/LED module during or immediately after use. Contact may cause burns.
5. If smoke or abnormal noise is detected, stop using and turn off the borescope immediately.
6. Do not look directly at the light from the end of the insertion tube. It is extremely bright and can cause eye damage.
7. If any abnormality is noticed during operation, stop using and turn off the borescope immediately.

ATTENTION

1. **Only use** this borescope within the approved operating temperature range.
2. **DO NOT** over-torque, bend, twist, or fold the insertion tube. Doing so could damage the articulation control wire assemblies and/or electrical wiring.
3. **Only use** the power adapter provided by ViewTech.
4. **DO NOT** yank or attempt to forcefully remove the insertion tube if it becomes stuck inside the equipment being borescoped. When extracting the insertion tube from the inspection area:
 - a. Be sure that the bending section (distal tip of the insertion tube) is straight. Use the joystick to remove any angle before attempting removal.
 - b. If the insertion tube becomes stuck during removal, gently rotate the joystick until it becomes loose again.
5. **After use**, center the joystick in order to straighten the bending section prior to storage. The borescope should always be stored with the bending section straight (do not force the bending section with your fingers – always use the joystick to adjust and straighten the bending angle.)

6. **NOTE** the following regarding the tip of the insertion tube, which is the most delicate part of this video borescope:
 - a. Do not impact the tip of the insertion tube while inserting or maneuvering inside the equipment being borescoped.
 - b. Manipulate the joystick gently. Rapid movement of the joystick while borescoping may cause abrupt impact with the machinery and result in damage to the camera/LED module.
7. **If** the lens is dirty or greasy, it may be cleaned by wiping with alcohol.
8. **DO NOT** force the joystick! If there is unusual resistance to joystick movement while conducting an inspection, it is because there is physical resistance inside the inspection area. Trying to force the joystick in this situation will result in damage to the articulation control wires, the joystick assembly or to the equipment being inspected.
9. **DO NOT** impact, press or scratch the LCD monitor.
10. **DO NOT** cover the unit with a plastic bag or other similar protective covering during use. It may cause the unit to overheat and damage the internal circuitry.
11. **DO NOT** use or store the borescope in a high temperature, high humidity or high radiation environment.

BATTERY AND BATTERY CHARGING

Follow the instructions below for battery care and proper charging, to prevent leakage, overheating, smoke, explosion, electric shock and burns.



DANGER

1. Only use batteries and chargers specially designed for this borescope: 18650B battery with PCB-protection (button top).
2. Be sure the battery is placed into the slot in the correct direction (+ /-).
3. Do not carry or store the battery where it may collide with metal objects.
4. Always keep the batteries away from fire or other sources of intense heat, as it will cause an explosion.
5. Do not attempt to open or modify batteries, as this could lead to an explosion or fire.
6. Do not immerse the battery in liquid of any kind.
7. Do not charge the battery near an open flame, as it could lead to an explosion or fire.
8. Do not drop, puncture, impact or apply pressure to the battery as it could lead to an explosion or fire.



WARNING

1. Use only 3.6V lithium batteries, model 18650B with PCB-protection (button top).
2. Submit a repair request immediately in case of battery leakage, discoloration, deformation or abnormal condition.
3. Clean immediately with tap water if your skin or clothing comes into contact with a leaking battery.
4. Keep the battery charger free of any covering during charging.
5. Do not charge the battery in the vicinity of flammable gas or materials.

ATTENTION

1. Do not use or store the battery or borescope in a high-temperature environment, such as direct sunlight, closed cars or near heating equipment.
2. The battery will heat up during prolonged operation. Do not remove immediately after use, as this could cause burns.
3. Keep battery and borescope out of the reach of children.
4. Do not touch the battery electrodes with wet hands.
5. Fully charge the battery before use and after extended use.
6. Remove the battery from the borescope if the scope will not be used for more than 30 days, otherwise, it may cause damage to the borescope, fire or personal injury.



REMINDER

1. This is a high-output battery. Please use the battery properly or it may cause damage from leakage or excessive heat. Always check the orientation/polarity and load it into the chamber correctly.
2. Battery performance will decrease as the ambient temperature drops. Performance will be restored once the ambient temperature rises.
3. Recycle the battery in accordance with the local regulations at the end of its useful life.
4. Recommended temperature range for this lithium ion battery is:
Discharging (in use): 0°C to 40°C (32°F to 104°F)
Charging: 0°C to 40°C (32°F to 104°F)
Storage: -10°C to 50°C (14° to 122°F)
5. Using, charging, or storing the battery at a temperature out of the above range will reduce the battery's performance and service life.
6. Be sure to remove the battery from the borescope for long term storage.

II

PRODUCT SPECIFICATIONS

Insertion Tube	Outer Diameter
	Length
	Exterior Material
	Chemical Compatibility
	Articulation Range
Optics	Field of View
	Depth of Field
	Effective Pixels
	Illumination Method
	Illumination Output
Base Unit	Display Monitor
	Articulation Control
	Joystick Lock
	Brightness Control
	Control Buttons
	Playback
	Audio / Microphone
	Internal storage
	Data I/O ports
	Battery
	AC Power (optional)
	Operating Method
	Dimensions
Weight	
Menu Functions and Options	User Interface
	File Management
	Image Control
	Image Format
	Video Format
	Language
Operating Limits	Run Time
	Operating Temp. Base Unit
	Operating Temp. Insertion Tube
	IP Rating, Insertion Tube
	IP Rating, Base Unit

6.0mm

6.0mm
1.5m, 3.0m, 5.0m, or 8.0m
Tungsten EasyGlide, crush-resistant
Water, machine oil, heating oil, diesel, 3.5% saline concentrate
360° around, 160±10° backward
100° x 75°
7.0mm - 80.0mm
450,000 pixels
6 Super high-intensity white LEDs
Front Camera ≤ 20,000lux
Side Camera ≤ 4,000lux
3.5" IPS anti-glare LCD, 640 x 480 resolution
Thumb-actuated, mechanical rocker
Automatic
6-step LED brightness adjustment
Image capture, video capture, LED control, frame rotation, freeze frame, 4X zoom, menu access / navigation
Photos, videos (w/wo audio), thumbnail view
3.5mm port
16 GB SD Card 10,000 photos, 8 hours video
SD card, micro USB, TV Out (NTSC / PAL)
One 18650B PCB-Protected Li-ion battery (replaceable)
100V - 240V
One handed, portable
13.0" x 12.0" x 4.5"
2.2 lbs. / 1.0 kg
Drop down operating menu
Photo and video recording, playback, thumbnail preview, delete
Image rotation, live freeze, zoom in/out
JPEG, optional date and time stamp
AVI, optional date and time stamp
English, Spanish
≤ 4 Hours
-20 – 50°C, -5 – 120°F
-10 – 50°C, 15 – 120°F
IP67
IP54

III PACKING LIST

ITEM

1	VJ-3 video borescope
2	18650B Li-ion battery (1 plus spare)
3	18650B Li-ion battery charger
4	Micro USB cable
5	AC power adapter
6	Video out cable
7	16GB SD card + card case
8	SD card reader
9	User manual
10	Quickstart guide

IV PRODUCT OVERVIEW

The VJ-3 mechanical articulating video borescope is a nondestructive visual testing instrument with integrated optics, illumination, image processing and joystick-actuated steering. It is used for the remote visual inspection of machinery, equipment and components. The VJ-3 facilitates the visual recording and photo documentation of an inspection of parts and areas of vital equipment that are otherwise inaccessible or that would require great effort and expense to access directly. The VJ-3 consists of two modules integrated into one system: the insertion tube with distally mounted camera/LEDs, and the base unit with control panel, LCD monitor, power source and all necessary circuitry.

The VJ-3 is available from the factory in a variety of configurations suitable for different tasks, with optional insertion tube lengths and diameters, as well as different light wavelengths: white, infrared, or ultraviolet.

The video signal from the VJ-3 can be viewed on the integrated LCD display or on an external hard-wired monitor.

DEFINITION OF KEY COMPONENTS

Fig. 2-1 VJ-3 Mechanical
Articulating Video Borescope

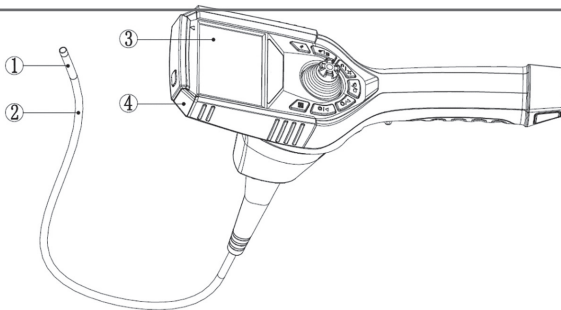

Fig. 2-2 Product image

1-Camera/LED module | 2-Insertion tube | 3-LCD | 4-Base unit

V PART NAMES AND FUNCTIONS

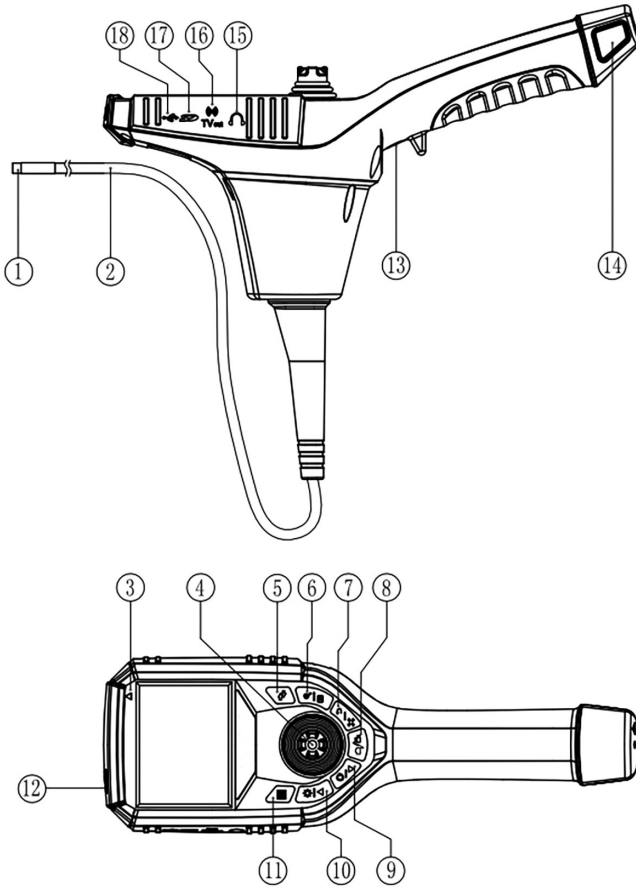

Fig. 5-1 Part names of the unit

- | | |
|---|--|
| 1. Camera/LED module | 10. Brightness control/Up button |
| 2. Insertion Tube | 11. Access device settings |
| 3. On-Off/Charging indicator | 12. On/Off button |
| 4. Joystick | 13. Image capture /Video start-stop |
| 5. Live Camera/Video/
Image Preview toggle | 14. Battery compartment |
| 6. Zoom/Playback button | 15. Headset/mic jack |
| 7. Image "Freeze Image"/
Back button | 16. TV Video Output Interface |
| 8. Image capture/Video start-stop | 17. SD card slot |
| 9. Image Rotation / Down button | 18. Micro USB / battery
recharging port |

VI PREPARATION

6.1 THE CASE

ATTENTION

Removing the instrument from the case:

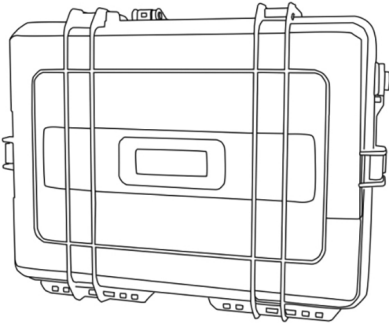
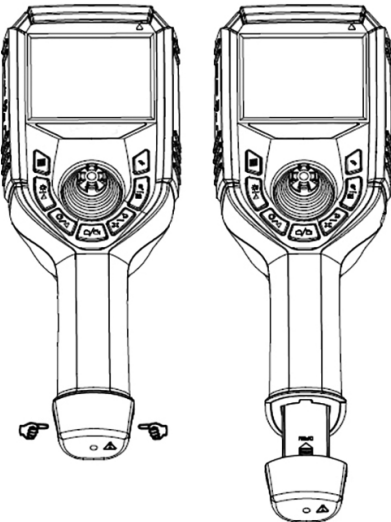

Fig. 6-2 The case

- Place the case flat on the floor, table, or other stable surface.
- After opening the case, first remove the insertion tube from the case and handle it gently.
- After the insertion tube is removed, use your other hand to grip and remove the base unit.

6.2 POWER SUPPLY PREPARATION

REMOVING BATTERY COMPARTMENT



Using your thumb and forefinger, press the two buttons on the sides of the battery chamber compartment at the base of the handle, and gently remove the battery compartment from the handle. (as shown in Fig. 6-3).

Fig. 6-3 Removing the battery compartment

OPENING THE BATTERY COMPARTMENT

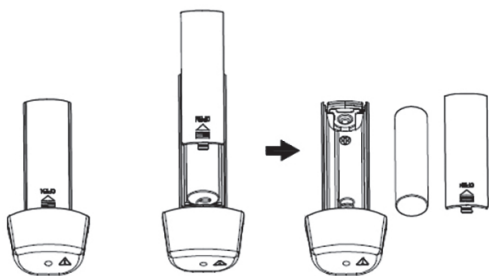

Push the compartment cover down gently with the thumb to open the battery compartment.

Fig. 6-4 *Opening the battery compartment*

LOADING THE BATTERY

Load the 18650B Li-ion battery according to the indications on the positive and negative electrode.

ATTENTION

- The battery cannot be placed in reverse polarity.
- Only one 18650B Li-ion battery is required.
- When needed, replace battery with a new 18650B Li-ion battery with PCB-protection circuit.

BUILT-IN / INTERNAL CHARGING

1. Connect the AC power adapter that is included with your kit to the unit's micro USB battery recharging port.
2. Plug the AC power adapter into a standard wall outlet.
3. The battery is charging when the On/Off Charging Indicator light is red. Charging is finished when this indicator light is green.

WARNING

- Use only the supplied AC power adapter for recharging the battery—input of 100-240 V (50/60 Hz) AC, output of DC5V 2A, with micro USB interface.
- Use of an adapter that does not comply with the above specifications will cause fire, electrical shock or severe damage to the battery and/or borescope, and will void the warranty.
- The power adapter provided with this product is not waterproof. It may cause electric shock if it comes into contact with water.

EXTERNAL CHARGING

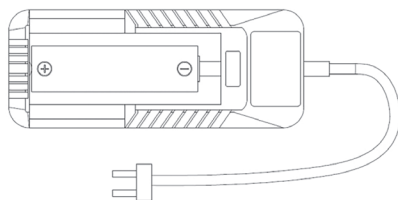

Fig. 6-5 *External charging*

1. Load the 18650B Li-ion battery into the battery charger with the positive end toward the top of the charger.
2. Plug the charger into a standard wall outlet.
3. The charging is finished when the charger shows 100% or the voltage shows 4.2V.



ATTENTION

- Ensure the battery is correctly loaded into the charger.
- The charger has built-in circuitry to prevent over-charging, however the batteries should be removed from the charger and placed back into the carrying case or the borescope after they are fully charged.

VII MENU OPERATION & FUNCTION

7.1 BUTTON POSITION

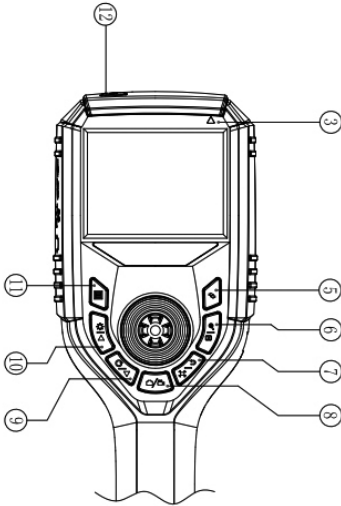

Fig. 7-1 Button interface, front view

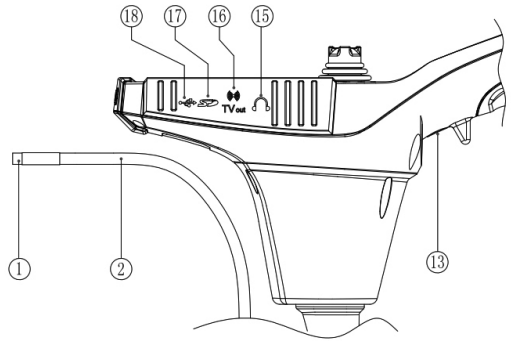









Fig. 7-2 Button interface, side view



1. Camera/LED module
2. Insertion Tube
3. On-Off/Charging indicator
4. Joystick
5. Live Camera/Video/ Image Preview toggle
6. Zoom/Playback button
7. Image "Freeze Image"/ Back button
8. Image capture/Video start-stop
9. Image Rotation / Down button
10. Brightness control/Up button
11. Access device settings
12. On/Off button
13. Image capture /Video start-stop
14. Battery compartment
15. Headset/mic jack
16. TV Video Output Interface
17. SD card slot
18. Micro USB / battery recharging port

7.2 BUTTON FUNCTION



	Press the button to Access Device Settings in any mode to display the main menu.
	The Brightness Control/Up button controls the LED output level and is used to scroll "Up" when in menu mode.
	The Image Rotation/Down button controls image rotation and mirroring and is used to scroll "Down" when in menu mode.
	The Zoom/Playback button is used to enlarge/zoom images in camera and video modes and to play a video when in playback mode.
	The Freeze/Back button is used to freeze/unfreeze live images and performs the "Back" function when in menu mode.
	The Live Camera/Video/Image Preview toggle is used to switch between three modes: <ul style="list-style-type: none">• camera (still image capture)• video (record video)• playback (view and play stored images and video).
	The Camera/Video trigger button under the handle grip and in the lower center of the main button array is used to take a photograph in camera mode, and to start/stop a video recording in video mode.
	The On/Off button on top of the unit is used for startup and shutdown of the borescope.



7.3 OVERVIEW OF MENU FUNCTIONS

7.3.1 SYSTEM SETTINGS MENU

1. Press the button to Access Device Settings  in any mode to enter the main menu. Then press the Live Camera/Video/Image Preview toggle  to select system settings, such as date and time, language, etc.
2. The system settings menu controls operational settings for the borescope in five categories: date and time, language, TV, automatic shutdown, and format/restore factory settings.

DATE AND TIME SETTING

This menu item is used for setting the time and the date that will be time-stamped onto the recorded images and video. Press the Live Camera/Video/Image Preview toggle  to switch options. Adjust the date by using the Brightness Control/Up button  and the Image Rotation/Down button .

Press the button to Access Device Settings  to set the current date, and the Freeze/Back button  to cancel the change and return to the prior menu.

LANGUAGE SETTING

This menu option is used to change the language used in the menus and on the display. Options are: English (En) or, Español (Es).

TV SETTING

This menu option is used for setting the TV output signal, either NTSC or PAL.

AUTOMATIC SHUTDOWN

This menu option is used to adjust the automatic shutdown, which is used to conserve battery life if the borescope is not in use for a specified period of time. Options include 3 minutes, 5 minutes, 9 minutes, and OFF.

FORMAT

This menu option will reformat the SD card. **CAUTION:** Reformatting the SD card will permanently delete all saved images and video files.

FACTORY RESET

This will restore all settings to factory default.

7.3.2 IMAGE SETTINGS MENU

Press the button to Access Device Settings  in any mode to enter the image setting menu. There are three items in the image settings menu: Camera Switch, Special Effect [Black and White/Normal (color)], and Date Stamp.

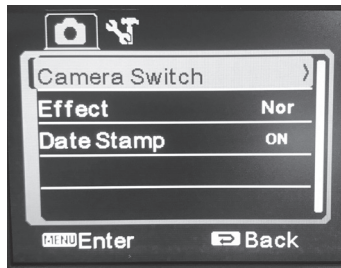

Fig. 7-3 Menu, image settings

Note: Video Settings menu options are the same as the image settings, above.

CAMERA SWITCH

This menu option is used to switch the current display between the forward view camera and side view camera.



SPECIAL EFFECT

This menu option is used to make the current display and any recorded images and video either black and white (BW) or normal (color).

DATE STAMP

This menu option is used to turn off or on the time stamp in the upper-right corner of photos and recorded video.



7.3.3 VIDEO SETTINGS MENU

Press the Live Camera/Video/Image Preview toggle  and switch to the video mode. To adjust the video settings, press the button to Access Device Settings  to enter the video settings menu. There are two items in the image settings menu: Special Effect [Black and White/Normal (color)], and Date Stamp.



7.3.4 IMAGE PLAYBACK SETTINGS MENU

ENTER PLAYBACK MODE

When a real-time image is displayed, press the Camera/Video/Image Playback  to switch to the playback mode. Then a single full-screen view of the recorded image will be displayed.

In the multi-image view, press the Brightness Control/Up button  and Image Rotation/Down button  to review and select. To enter the full screen view, select the desired image and press the Zoom/Play button .

PLAY VIDEO

In the full screen view, press the Zoom/Play button  to play/pause the recorded video. Press the Freeze/Back button  to exit during play.

FILE LOCKING/UNLOCKING

File locking is used to safeguard important recorded images or videos and protect them from accidental deletion. Options include: Lock/Unlock single, Lock all, and Unlock all.

7.3.5 A/V OUTPUT

To display the real-time borescope image on an external monitor (see Fig. 7-4), connect the AV cable to the monitor and to the TV Video Output Interface of the borescope.

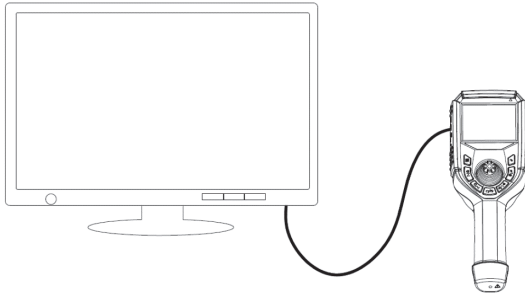

Fig. 7-4 *Connect the unit to a monitor
(image will be displayed only on the external monitor)*

VIII BASIC OPERATION

ATTENTION

Before turning on the borescope:

- Insert the SD card, otherwise all image capture and video recording functionality will be inoperative.
- Check the lens for any dirt, grime or debris. Clean as necessary, using the cleaning swabs provided, being careful not to flex the bending section while doing so.



8.1 TURNING ON/OFF

Press the on-off button  (see Fig. 8-1) near the top corner of the base unit. The borescope will power up and the LCD will display the real-time image captured by the camera/LED module.

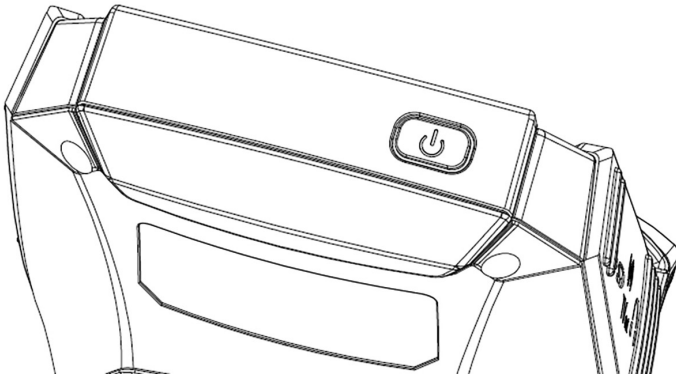

Fig. 8-1 On/Off button

8.2 INSERTING THE INSERTION TUBE INTO THE MACHINERY OR EQUIPMENT BEING BORESCOPED

Inserting the insertion tube

Make sure the insertion tube and bending section are straight before starting the inspection.

DO NOT attempt to articulate the bending section with the joystick while the insertion tube is coiled, as this will result in breakage of the articulation control wires.

- After the insertion tube enters the inspection port, adjust the brightness as necessary and use the LCD monitor to see the internal view.
- Manipulate the joystick as needed in order to steer the insertion tube and camera/LED module to the inspection target.



REMINDER

STOP IMMEDIATELY if the joystick control mechanism does not respond to normal inputs or any abnormality occurs during operation. Move the joystick to the center position and carefully extract the insertion tube from of the inspection area.

8.2.1 EXTRACTING THE INSERTION TUBE

1. Move the joystick to the center/neutral position.
2. Withdraw the insertion tube slowly, being careful to hold on to it with one hand so that it does not drop after it exits the inspection access port.



WARNING

- Do not remove the insertion tube when the bending section is at an angle. Doing so could damage the bending section and/or the equipment being inspected.
- If the insertion tube becomes stuck during the extraction, gently rotate the joystick until it becomes dislodged, and then pull the insertion tube out. Never yank or forcefully remove the insertion tube.

8.3 IMAGE DISPLAY ADJUSTMENT

8.3.1 FREEZE A LIVE IMAGE

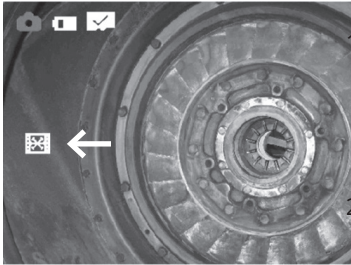



1. When in live image mode, press the Freeze/Back button . The live screen image will be frozen and an indicator will show on the left side of the display (see Fig. 8-2).
2. Press the Freeze/Back button  again to unfreeze the image.

Fig. 8-2 Freeze indicator icon

REMINDER

- Do not insert or remove the insertion tube when the image is frozen. You will be unable to visually guide the insertion with a frozen image.
- The frozen image may be blurry if it was captured while the camera/insertion tube was in motion.

8.3.2 ENLARGE THE IMAGE (ZOOM)

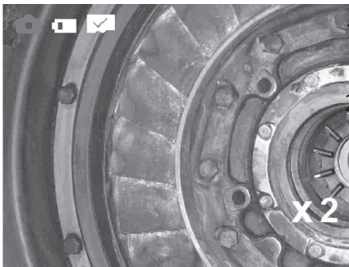





1. The display image can magnified up to 4X by pressing the Zoom/Playback button .
2. Press the Zoom/Play button  until it returns to the original size. During the zoom operation, the magnification level will appear at the bottom right of the screen (Fig. 8-3).

Fig. 8-3 Zoom indicator

8.3.3 LED ILLUMINATION ADJUSTMENT

During live viewing mode, LED brightness can be changed by pressing the Brightness Control/Up button . Repeatedly pressing this button will cycle the LEDs through 6 stages of brightness and OFF. The LED level is indicated on the screen.

8.3.4 IMAGE ROTATION

1. The live image can be flipped and mirrored in three different ways by pressing the Image Flip/Down button .

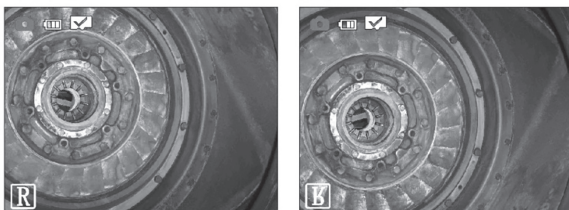

2. Press  a second time and the live image becomes mirrored.



3. Press  a third time and the live image becomes flipped 180° and mirrored.

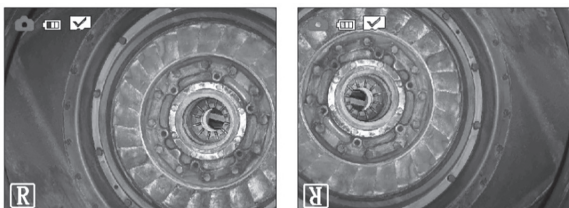

4. Press  a fourth time and the live image reverts to its original orientation.

8.4 RECORDING IMAGES

Still images and video can be recorded during live view mode and are stored on the SD card.

8.4.1 LOADING THE SD CARD

1. Open the rubber cover on the left side of the base unit.
2. Insert the SD card into the slot with the card's notch pointed toward the top of the base unit, then close the rubber cover.

REMINDER

- The SD card is not properly aligned if it does not slide smoothly into the slot. Please check the direction of the card and never use force.
- The file name will be automatically generated when saving images on the SD card.
- For the filename extension, “.JPG” represents the still image file, and “.AVI” represents the video file.
- File numbers are assigned sequentially from 0001 to 9999.

8.4.2 TAKING STILL IMAGES

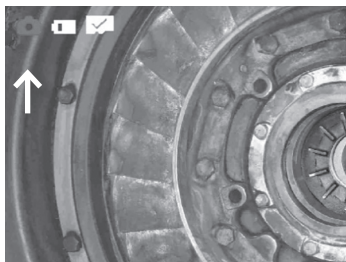



1. When a real-time image is displayed, press Live Camera/Video/Image Preview toggle  to switch the mode to camera (see Fig. 8-4).
2. Press the Camera/Video trigger button  under the handle grip or in the lower center of the button array to record a still image.

Fig. 8-4 Camera mode indicator

8.4.3 RECORDING VIDEO





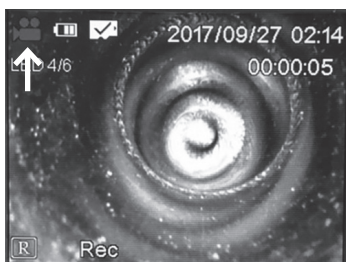

1. When a real-time image is displayed, press Live Camera/Video/Image Preview toggle  to switch the mode to video (see Fig. 8-5).
2. Press the Camera/Video trigger button  to record video. Press it again to stop recording.

Fig. 8-5 Video mode indicator

8.5 IMAGE PLAYBACK

There are two screen views that display recorded images: a full screen view of a single image, and a multi-image view of thumbnails.

8.5.1 MULTI-IMAGE VIEW (THUMBNAILS)

When a real-time image is displayed, press Live Camera/Video/Image Preview toggle . Press the Freeze/Back button , and the multi-image view (see Fig. 8-6) will be displayed. Press the Zoom/Playback button  to enlarge the image selected.

REMINDER

- Nine thumbnails maximum can be displayed on the screen.
- A video indicator icon  appears on the lower left of each thumbnail that is a video.

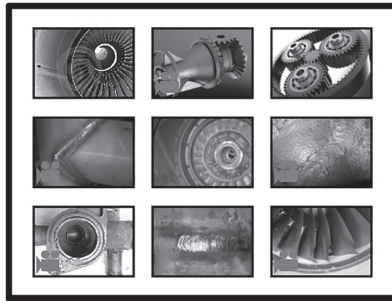





Fig. 8-6 Multi-image (thumbnail) view (with video indicator icons)

8.5.2 FULL SCREEN VIEW

1. While in multi-image view, select the pictures or videos to watch by using the Brightness Control/Up button  and Image Rotation/Down button  and then, when the desired image/video is selected, press the Zoom/Playback button  to enter full-screen view for that image or video.
2. To return the multi-image view from the state of full-screen image view or video, use the Freeze/Back button.

8.6 DELETING IMAGES AND VIDEO

8.6.1 DELETING INDIVIDUAL IMAGES/VIDEOS

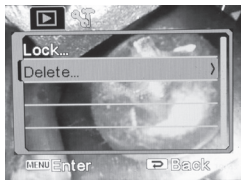



1. Press the Image Preview toggle  repeatedly until you enter image/video playback.

2. Navigate to the image/video you want to remove as outlined in section 8.5.



3. In Zoom/Playback, when the image/video is enlarged. Press the Menu/Access Device Settings button .

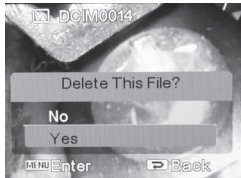

4. Press the Image Rotation/Down button  to highlight "delete," followed by the menu button to make your selection.

5. On the next screen, select "One" by pressing the Menu/Access Device Settings button .





6. When prompted "Delete this file?" Press the Image Rotation/Down button  to highlight "Yes" followed by the Menu/Access Device Settings button  to confirm.

8.6.2 DELETING ALL IMAGES/VIDEOS





1. Press the Image Preview toggle  repeatedly until you enter image/video playback.

2. With any image/video in preview mode press the Menu/Access Device Settings button .

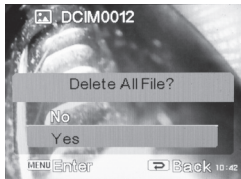
3. Press the Image Rotation/Down button  to highlight "Delete," followed by the Menu/Access Device Settings button  to select.





4. On the following screen, Image Rotation/Down button  to highlight "All," followed by the Menu/Access Device Settings button  to select.

5. When prompted to "Delete All File?" press the Image Rotation/Down button  to highlight "Yes" followed by the menu button to confirm.

REMINDER

All Images and Video can be viewed, organized and deleted by removing the SD card (8.4.1) from the VJ-3 Borescope and using the supplied SD card reader with your computer.

8.7 MENU OPERATION

1. While in camera, video or playback mode with full screen view, press the Access Device Settings button  to display the main menu. To navigate the menu, use the Brightness Control/Up button  and Image Rotation/Down button .

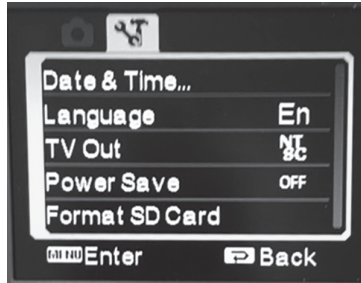





Fig. 8-7 Menu display

2. To select a menu item or enter a sub-menu item, press the Access Device Settings button .
3. To return to the upper menu or exit a menu selection, press the Freeze/Back button .
4. Menu options are divided into two categories:
 - Current image options
 - System settings
5. Press the Live Camera/Video/Image Preview toggle  to alternate between these two categories.

9.1 CLEANING

CLEANING THE INSERTION TUBE

1. Wipe dirt, grease, grime and liquids from the insertion tube with a dust-free cloth.
2. Make sure that the insertion tube is completely dry before replacing the borescope back into the case.



WARNING

Do not store the borescope in a high temperature, high humidity, or corrosive environment.

CLEANING THE LCD SCREEN

If the LCD screen has fingerprints, grease or stains, wipe the screen with a dust-free cloth.

CLEANING THE BASE UNIT

Wipe the base unit with a dust-free cloth as needed.

9.2 REPACKING

1. Return the borescope to the case carefully in order to avoid unintentional damage to the insertion tube or camera/LED module.
 2. Be sure that the joystick is in the center/neutral position and that the bending section is straight, prior to inserting the borescope into the case.
 3. When returning the borescope to the case, first place the base unit into the case, then carefully feed the insertion tube into and around the slotted channel in the case that is designed to house the insertion tube.
-
-

9.3 STORAGE

Store at normal room temperature and humidity.

X TROUBLESHOOTING

If malfunctions cannot be resolved by following the troubleshooting guidelines below, please contact ViewTech for more detailed troubleshooting instructions or to request a Return Merchandise Authorization (RMA) and repair ticket:

10.1 TROUBLESHOOTING GUIDELINES

MALFUNCTION	POSSIBLE CAUSES	PROPOSED MEASURES
Unable to capture images or video	No SD card	Install the SD card correctly
Still showing no SD card after insertion of SD card	SD card is not inserted properly	Re-insert the SD card into the slot
Automatic shutdown	Triggered by too high ambient temperature	Stop using, allow unit to cool down, and then restart
	Triggered by too low battery level	Charge the battery
Unclear image	The camera lens or LCD monitor is dirty	Wipe clean with a dust-free cloth or swabs
Joystick resistance feels high—A lot of pressure is required to move the joystick	The insertion tube is coiled or bent too much	Straighten the insertion tube as much as possible

10.2 REPAIR

- Please contact ViewTech before sending your borescope in for repair. A detailed description of the problem and an overview of the operating environment or accident that may have caused the damage will be requested.
- Servicing and repair of this borescope is to be performed only by ViewTech. Do not disassemble or attempt to repair this borescope, as this will immediately void the warranty.

PRODUCT WARRANTY

The purchased product is covered under the manufacturer product warranty. The warranty becomes effective on the date the purchaser receives the original product. The warranty period is twelve months from the effective date. During the warranty period, the manufacturer will repair, at manufacturer's expense (including shipping expenses), any defective products or components. This warranty covers only those repairs that become necessary due to product defects or defects in manufacturer workmanship. This warranty does not cover damage to the purchased products due to misuse, abuse or accidents involving the products.

INVALIDITY OF PRODUCT WARRANTY

The manufacturer product warranty will be void regardless of the remaining warranty period if the product is opened, customized, or tampered with by an unauthorized technician. If any repair or modification is performed by an unauthorized technician, ViewTech will not be responsible or liable for any damage to persons or property that may result.



REPAIR PROCEDURE

To initiate a repair, regardless of whether the repair is under warranty or not, an RMA (Return Merchandise Authorization) number must be obtained. Any item(s) returned without an RMA number cannot be accepted or processed. Please follow the repair procedure as indicated below:

- Call ViewTech at 231-943-1171 to request a Return Merchandise Authorization (RMA) Number.
- Package the unit securely and ship the product to the address that will be provided along with the RMA number.
- Upon completion of the repair, the unit will be returned to the address specified by the customer.

If the repair falls outside the warranty terms or the warranty period, customer will receive notice of the repair charges prior to repair.

CERTIFICATIONS

<p>Low voltage directive and EMC directive</p> 	<p>Conforms to CE</p>
<p>WEEE directive</p> 	<p>Conforms to WEEE</p>
<p>RoHS directive</p> 	<p>Conforms to RoHS</p>



Traverse City, Michigan, USA

231.943.1171

WWW.VIEWTECH.COM